

## Operating Instructions

### A 950 II

Grinding Machine for Sickle-shaped and Circular Knives



# Operating Instructions

---

## Grinding Machine for Sickle-shaped and Circular Knives A 950 II

### Manufacturer

KNECHT Maschinenbau GmbH  
Witschwender Straße 26  
88368 Bergatreute  
Germany

Phone +49-7527-928-0  
Fax +49-7527-928-32

mail@knecht.eu  
www.knecht.eu

### Documents for the machine operator

Operating instructions

### Date of issue of the operating instructions

February 26, 2024

### Copyright

The copyright for these operating instructions and documents is held by KNECHT Maschinenbau GmbH. These documents will be delivered only to our customers and to operators of our products and are a part of the machine.

These documents may neither be reproduced, nor made accessible to third parties, including rival firms, without our express permission.

# Table of contents

---

<b>1.</b>	<b>Important notes</b>	<b>7</b>
<b>1.1</b>	<b>Preface to the operating instructions</b>	<b>7</b>
<b>1.2</b>	<b>Warnings and symbols in the operating instructions</b>	<b>7</b>
<b>1.3</b>	<b>Warning and mandatory signs and what they mean</b>	<b>8</b>
1.3.1	Warning and mandatory signs on/in the grinding machine	8
1.3.2	General mandatory signs	8
<b>1.4</b>	<b>Rating plate and serial number</b>	<b>9</b>
<b>1.5</b>	<b>Figure and item numbers in the operating instructions</b>	<b>10</b>
<b>2.</b>	<b>Safety</b>	<b>11</b>
<b>2.1</b>	<b>Basic safety instructions</b>	<b>11</b>
2.1.1	Observe notes in the operating instructions	11
2.1.2	Obligation on the part of the operator	11
2.1.3	Obligation on the part of the personnel	11
2.1.4	Hazards involved in handling the grinding machine	11
2.1.5	Malfunction	12
<b>2.2</b>	<b>Intended use</b>	<b>12</b>
<b>2.3</b>	<b>Warranty and liability</b>	<b>12</b>
<b>2.4</b>	<b>Safety regulations</b>	<b>13</b>
2.4.1	Organizational measures	13
2.4.2	Protective equipment	13
2.4.3	Informal safety measures	13
2.4.4	Selection and qualification of personnel	13
2.4.5	Machine control system	14
2.4.6	Safety measures in normal operation	14
2.4.7	Hazards due to electrical power sources	14
2.4.8	Particular hazard zones	14
2.4.9	Servicing (maintenance, repair) and fault elimination	15
2.4.10	Structural modifications to the grinding machine	15
2.4.11	Cleaning the machine	15
2.4.12	Oils and greases	15
2.4.13	Relocation of the grinding machine	15
<b>3.</b>	<b>Description</b>	<b>17</b>
<b>3.1</b>	<b>Intended use</b>	<b>17</b>
<b>3.2</b>	<b>Technical specifications</b>	<b>17</b>
<b>3.3</b>	<b>Functional description</b>	<b>18</b>
<b>3.4</b>	<b>Description of modules</b>	<b>19</b>
3.4.1	Switching the grinding machine on/off	21
3.4.2	Control panel	22
3.4.3	Layout of user interface (main screen)	23

# Table of contents

---

<b>4.</b>	<b>Transport</b>	<b>24</b>
4.1	Transport aids	24
4.2	Transport damage	24
4.3	Transport to another installation site	24
<b>5.</b>	<b>Installation</b>	<b>25</b>
5.1	Selection of qualified personnel	25
5.2	Installation site	25
5.3	Supply connections	25
5.4	Settings	25
5.5	Using the grinding machine for the first time	26
<b>6.</b>	<b>Commissioning</b>	<b>27</b>
<b>7.</b>	<b>Operation</b>	<b>29</b>
7.1	Switch on the grinding machine	29
7.2	Grind knives	29
7.2.1	Load grinding program	29
7.2.2	Mount cam disc SP 116	30
7.2.3	Grind the slicer knife without suspension attachment	33
7.2.4	Grinding the slicer knife with suspension attachment	35
7.2.5	Grind circular knives	37
7.2.6	Set the knife at the center of the disc	39
7.3	Dressing the front/rear grinding wheel	40
7.4	Changing the front/rear grinding wheels	42
7.5	Adjusting the grinding angle	44
<b>8.</b>	<b>Control system</b>	<b>45</b>
8.1	Main screen	45
8.2	Grinding program	46
8.3	Grinding data	47
8.3.1	Data	48
8.3.2	Abrasives	48
8.3.3	Steps	48
8.4	Settings	50
8.5	Axes in manual mode	51
8.6	Manual functions	53
8.6.1	General	53
8.6.2	Grinding wheel front	54

# Table of contents

---

8.6.3	Grinding wheel rear	54
8.6.4	Knife assembly	54
<b>8.7</b>	<b>Machine data</b>	<b>56</b>
8.7.1	General	56
8.7.2	Options	57
8.7.3	Holder	57
8.7.4	Tools – Grinding wheel front/rear	57
<b>8.8</b>	<b>Message texts</b>	<b>58</b>
<b>8.9</b>	<b>Options</b>	<b>59</b>
<b>8.10</b>	<b>Language</b>	<b>60</b>
<b>8.11</b>	<b>Setting up an internet connection</b>	<b>61</b>
<b>9.</b>	<b>Care and maintenance</b>	<b>62</b>
<hr/>		
9.1	Coolant	62
9.2	Lubricate cross table	62
9.3	Clean grinding machine	63
9.4	Other lubrication points	63
<b>10.</b>	<b>Malfunctions</b>	<b>64</b>
<hr/>		
10.1	Faults	64
<b>11.</b>	<b>Disassembly and disposal</b>	<b>65</b>
<hr/>		
11.1	Disassembly	65
11.2	Disposal	65
<b>12.</b>	<b>Service, spare parts and accessories</b>	<b>66</b>
<hr/>		
12.1	Postal address	66
12.2	Service	66
12.3	Wear and spare parts	66
12.4	Accessories	67
12.4.1	Abrasives used	67
<b>13.</b>	<b>Appendix</b>	<b>68</b>
<hr/>		
13.1	EU Declaration of Conformity	68

# 1. Important notes

---

## 1.1 Preface to the operating instructions

These operating instructions are designed to make it easier for users to familiarize themselves with the grinding machine for sickle-shaped and circular Knives, also referred to in the following as “the grinding machine” and use it for its intended purpose. The term “knife” can also be used for the term “slicer knife”.

The operating instructions contain important information on how to operate the grinding machine safely, properly and cost-effectively. Observance of these instructions helps avoid hazards, reduce repair costs and downtimes, and increase the reliability and service life of the grinding machine.

The operating instructions must always be accessible at the place of use of the grinding machine.

The operating instructions must be read and used by all persons entrusted with working on the grinding machine, e.g. those entrusted with:

- transportation, installation, commissioning
- operation, including fault elimination in the process flow
- servicing (maintenance, repair)

In addition to the operating instructions and the binding accident prevention regulations applicable in the country and place in which the machine is used, generally acknowledged technological rules with regard to safe and professional work practices are to be observed.

## 1.2 Warnings and symbols in the operating instructions

It is essential to observe the following symbols/designations used in the operating instructions.



The hazard triangle with the signal word “CAUTION” serves as a work safety notice for all work for which there is a risk of personal injury or death.

In these cases, work should be done with special attention and care.



“ATTENTION” is written in places where special attention must be paid to prevent damage or destruction of the grinding machine or its surroundings.



“NOTICE” refers to user tips and especially useful informations.

# 1. Important notes

---

## 1.3 Warning and mandatory signs and what they mean

### 1.3.1 Warning and mandatory signs on/in the grinding machine

The following warnings and mandatory signs have been affixed on/in the grinding machine:



#### **CAUTION! DANGEROUS ELECTRICAL VOLTAGE (warning notice on the control panel)**

The grinding machine carries life-threatening voltage when it is connected to the power supply.

Voltage-carrying device parts may only be opened by authorized personnel.

The grinding machine must be separated from the mains supply before carrying out servicing, maintenance and repair work on it.



#### **CAUTION! RISK OF INJURY FROM KNIFE (prohibition sign on the base plate)**

Work on the grinding machine involves grinding knives which could cause serious cut injuries due to the sharp blades.

Wearing protective gloves is mandatory when carrying out such jobs.

Caution when transporting knives. Use the protective equipment provided by the knife manufacturer. Protective gloves and safety shoes must be worn.

### 1.3.2 General mandatory signs

The following general mandatory signs must be observed:



#### **CAUTION! RISK OF INJURY DUE FROM ABRASIVE PARTICLES DURING DRESSING**

Dressing the grinding wheel gives rise to abrasive particles which can enter the eyes.

Wearing safety glasses is mandatory when carrying out such jobs.

# 1. Important notes

---

## 1.4 Rating plate and serial number



The rating plate is located on the right side of the machine behind the switch cabinet.

**Figure 1-1** Rating plate

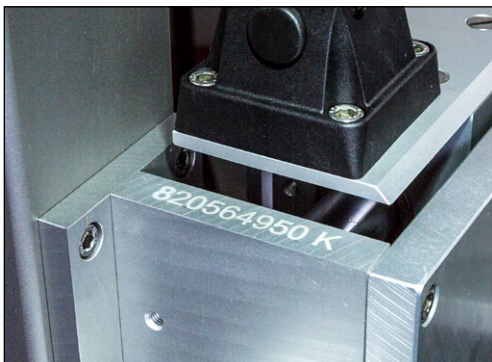

The serial number is located on the rating plate and on the front left of the machine.

**Figure 1-2** Serial number



# 1. Important notes

---

## 1.5 Figure and item numbers in the operating instructions

If the text refers to a machine component shown in a figure, a figure or item number is added in brackets after the machine component.

Example: (7-25/1) denotes figure number 7-25, item 1.

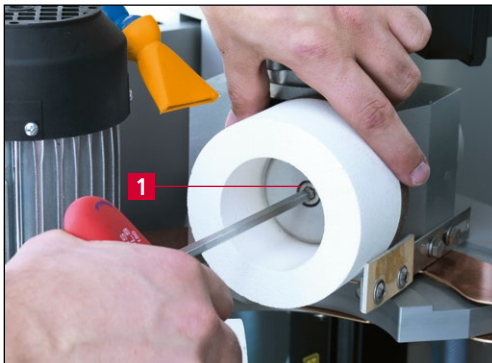

**Figure 7-25** Change grinding wheels

*Use SW6mm Allen wrench to loosen and remove the screw at the center of the grinding wheel (7-25/1) by turning it counter-clockwise.*

*Remove the front or rear grinding wheel and also the connection flange (7-26/1) if necessary and mount the new grinding wheel in the reverse order.*

## 2. Safety

---

### 2.1 Basic safety instructions

#### 2.1.1 Observe notes in the operating instructions

The basic prerequisite for safe handling and trouble-free operation of this grinding machine is familiarity with the basic safety instructions and regulations.

- This user manual contains important notes on how to operate the grinding machine safely.
- This user manual, in particularly the safety notes, is to be read by all those who work at the grinding machine.
- In addition, the rules and regulations regarding accident prevention at the place of use are to be observed.

#### 2.1.2 Obligation on the part of the operator

The operator is obliged to allow only those persons to work on the grinding machine, who

- are familiar with the occupational safety and accident prevention regulations and have been received instruction in handling the grinding machine
- have read and understood the operating instructions, in particular the section entitled "Safety" and the warning notes, and have provided signed confirmation of this.

Checks are also carried out at regular intervals to ensure that the personnel are fulfilling their obligation to observe safety at work.

#### 2.1.3 Obligation on the part of the personnel

All personnel working on the grinding machine undertake to

- observe basic occupational safety and accident prevention regulations
- read the operating instructions, particularly the section entitled "Safety" and the warning notes, and provide signed confirmation of this

#### 2.1.4 Hazards involved in handling the grinding machine

The grinding machine has been built to the latest technological standards and the established rules of technical safety. In spite of this, its use poses inherent risks which could result in bodily harm or even death of the user or third parties, or impairment of the grinding machine or other property. The grinding machine may only be used:

- for its intended purpose
- in faultless condition with regard to safety-related aspects

Faults that might impair safety must be eliminated immediately.

## 2. Safety

---

### 2.1.5 Malfunction

If any safety-relevant malfunction occurs in the grinding machine or if the processing response indicates that such malfunction may have occurred, the grinding machine must be stopped immediately until such time as the malfunction has been detected and eliminated.

Malfunctions may only be eliminated by authorized specialists.

### 2.2 Intended use

The grinding machine is only designed for grinding slicer knives. Before starting work on a slicer knife, a check must first be carried out as to whether the slicer knife fits onto the cam disc. Only then may the slicer knife be clamped onto the cam disc.

Any other use is considered improper use. KNECHT Maschinenbau GmbH assumes no liability for damages resulting from improper use. The user alone bears the risk in such cases.

Use as intended includes the observance of all the instructions in the operating instructions.

#### **ATTENTION**

**Improper use of the grinding machine exists, for example, if:**

- **the slicer knife is removed without the cam disc**
- **attachments are not properly mounted**

### 2.3 Warranty and liability

Warranty and liability claims in case of personal injuries or property damage are excluded if such damage is attributable to one or more of the following causes:

- improper use of the grinding machine
- improper transportation, commissioning, operation and maintenance of the grinding machine
- operating the grinding machine with defective safety devices, or using improperly attached or malfunctioning safety and protective equipment
- failure to observe the instructions with regard to transportation, commissioning, operation, maintenance and repair of the grinding machine
- unauthorized structural alterations to the grinding machine
- unauthorized modification of such aspects as drive conditions (power and speed)
- insufficient monitoring of machine parts that are exposed to wear

## 2. Safety

---

- use of unapproved replacement and wear parts

Use only original replacement and wear parts. If externally purchased parts are used, it is not guaranteed that they have been designed and manufactured to meet the requirements in terms of stress and safety.

### 2.4 Safety regulations

#### 2.4.1 Organizational measures

All available safety devices must be checked regularly.

Observe prescribed intervals for recurring maintenance work or as specified in the operating instructions.

#### 2.4.2 Protective equipment

Before every commissioning of the grinding machine, ensure that all protective equipment is properly mounted and in functional condition.

Protective equipment may be removed only after the grinding machine has stopped and has been secured against accidental restart.

When attaching spare parts, the protective equipment must be attached by the operator as stipulated.

#### 2.4.3 Informal safety measures

The operating instructions must be permanently available at the place of use of the grinding machine. In addition to the operating instructions, the generally applicable as well as the locally relevant accident prevention regulations must also be made available and observed.

All safety alert symbols and danger warnings on the grinding machine must be complete and clearly legible.

#### 2.4.4 Selection and qualification of personnel

Only trained and instructed personnel may work on the grinding machine. The minimum legal age for employment must be observed.

The responsibilities of the personnel must be clearly assigned, i.e. commissioning, operation, maintenance and repair, etc.

Personnel still undergoing training or instruction may only work on the grinding machine under the permanent supervision of an experienced person!

## 2. Safety

---

### 2.4.5 Machine control system

Under no circumstances make program changes to the software. Parameters that the operator can set himself are excluded from this (e.g. setting the number of cycles).

Only trained and instructed personnel are permitted to switch on and operate the machine.

### 2.4.6 Safety measures in normal operation

Refrain from any method of working which may pose a risk to safety. Only operate the grinding machine if all the safety devices are installed and fully functional.

Check the grinding machine for external signs of damage and correct operation of the safety devices at least once every shift.

Report any changes (including operating behavior) immediately to the department/person in charge. Where required, shut down the grinding machine immediately and secure against restarting.

Before switching on the grinding machine, ensure that no one is exposed to any risk from the start-up of the machine.

If there are any functional faults, stop the machine immediately and secure against restarting. Have the faults eliminated immediately.

### 2.4.7 Hazards due to electrical power sources

The control cabinet must always be kept closed. Access is only permitted to authorized personnel.

Work on electrical units or operating materials may only be performed by a qualified electrician in accordance with electrical rules.

Defects, such as damaged cables, cable connections, etc. must immediately be rectified by an authorized electrician.



**The yellow power supply cable is electrically live even when the main switch is turned off.**

### 2.4.8 Particular hazard zones

In the area of the grinding wheels, there is a danger of pinching and being drawn in (e.g. clothing, fingers and hair). Suitable personal protective equipment must be worn.

## 2. Safety

---

### 2.4.9 Servicing (maintenance, repair) and fault elimination

Maintenance work is to be carried out on schedule by trained personnel. Inform operating personnel before beginning repair work. Designate a supervisor responsible for this.

For all service work, the grinding machine is to be disconnected from the current supply and secured against accidental restart. Remove power plug. Secure repair area as necessary.

After completing maintenance work and rectifying any faults, install all safety devices and verify that they are fully functional.

### 2.4.10 Structural modifications to the grinding machine

Do not make any changes, additions or conversions to the grinding machine without the approval of the manufacturer. This also applies to the installation and setup of safety devices.

Any conversion work requires the written permission from KNECHT Maschinenbau GmbH.

Immediately replace machine parts that are not in perfect condition.

Use only original replacement and wear parts. If externally purchased parts are used, it is not guaranteed that they have been designed and manufactured to meet the requirements in terms of stress and safety.

### 2.4.11 Cleaning the machine

Properly handle any cleaning agents and materials used and dispose of them in an environmentally-friendly manner.

Dispose of the wear parts and replacement parts in a safe and environmentally-friendly manner.

### 2.4.12 Oils and greases

When using oils and greases, follow the safety regulations applicable to the product. Comply with the special regulations for the food areas.

### 2.4.13 Relocation of the grinding machine

Disconnect the grinding machine from any external power supply, even in the event of a minor change of location. Before restarting the grinding machine, connect it properly to the power supply.

For loading work, use only lifting equipment and load-bearing devices with sufficient lifting capacity. Appoint a qualified instructor for the lifting operation.

No persons other than those designated for this work may be present in the loading and installation area.

## 2. Safety

---

Only lift the grinding machine properly with lifting gear as specified in the operating instructions. Only use a suitable transport vehicle with sufficient load-bearing capacity. Secure the load reliably. Use suitable attachment points (Chapter 4.1).

When restarting the machine, proceed only in accordance with the operating instructions.

# 3. Description

---

## 3.1 Intended use

The grinding machine for sickle-shaped and circular knives A 950 II grinds slicer knives (sickle-shaped or circular) up to a maximum size of 900 mm. It is not suitable for grinding other types of knife such as hand knives.

## 3.2 Technical specifications

Height	1832 mm
Width	1709 mm
Depth	997 mm
Required space (BxD)	2500 x 2000 mm
Weight	400 kg
Power supply	3x 400 V
Mains frequency	50 Hz
Output	0.5 kW
Power consumption	1.9 kW
Energy consumption	4 A
Back-up fuse	16 A
Control voltage	+ 24 V DC
Compressed air supply according ISO 8573-1:2010 [1:4:2]	6 bar (50 l/min)
Measured A-evaluated emission sound pressure level at workstation LpA*	72 dB (A)
Speed of grinding wheels, front/rear	255 rpm
Grinding wheel A	d.100xd.40x60

\*) Dual number noise emission value information according to EN ISO 4871 (measurement uncertainty KpA. 3 dB (A)). Emission sound pressure level according to EN ISO 11201. A slicer knife was ground (type known to KNECHT Maschinenbau GmbH).



## 3. Description

---

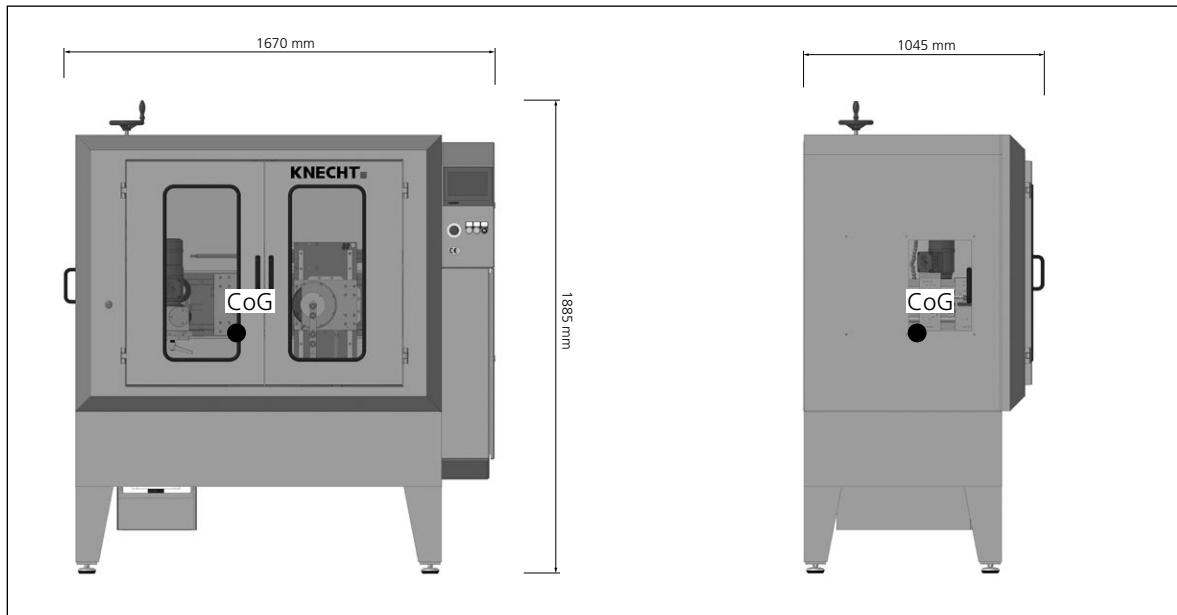

**Figure 3-1** Dimensions in mm

### 3.3 Functional description

The grinding machine can be used to automatically sharpen slicer knives (sickle-shaped or circular knives) with a size of maximum 900 mm.

The slicer knife is clamped onto a cam disc and sharpened along the knife edge by the grinding wheel precisely according to its shape.

In case of emergency, the grinding machine can immediately be stopped by pressing the "Emergency Stop" button

# 3. Description

## 3.4 Description of modules

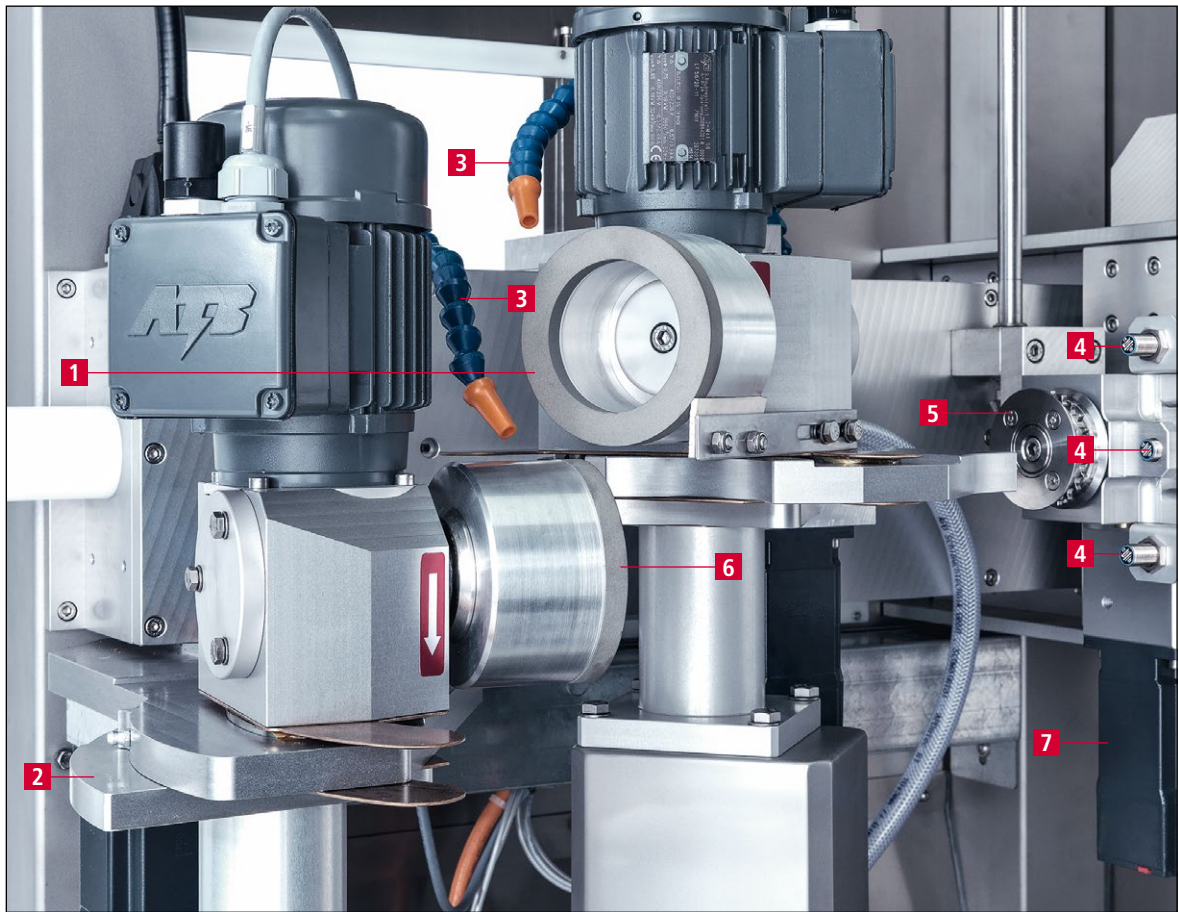

**Figure 3-2** General view of grinding machine

- 1 Hand wheel for grinding depth
- 2 Grinding unit
- 3 Water tray
- 4 Control unit with control panel
- 5 Cam disc SP 116 (with knife)
- 6 Water regulator
- 7 Machine feet

### 3. Description

---



**Figure 3-3** Grinding unit

- 1 Grinding wheel (rear)
- 2 Angle adjustment scale
- 3 Coolant hose
- 4 Inductive switch
- 5 Drive pinion of cam disc
- 6 Grinding wheel (front)
- 7 Cam disc drive (servo motor)

# 3. Description

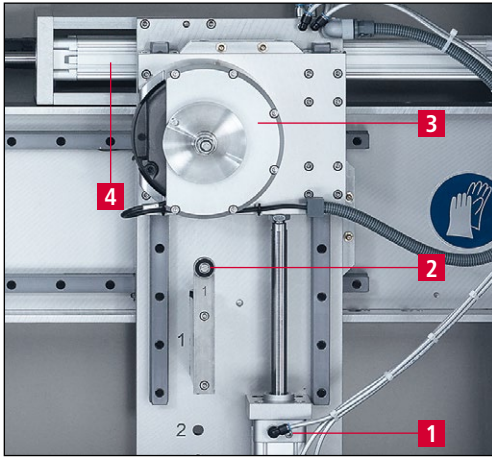

Figure 3-4 Cam disc bracket

- 1 Cylinder knife assembly up/down
- 2 Z coupling
- 3 Cam disc bracket
- 4 Cylinder for pressing on cam disc

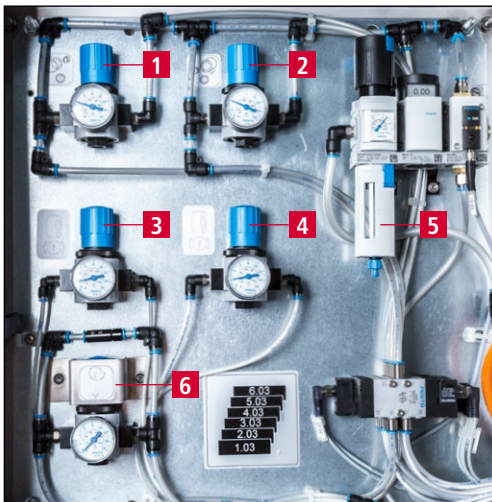

Figure 3-5 Pneumatic cabinet

- 1 Pressure on front grinding wheel
- 2 Pressure on rear grinding wheel
- 3 Front grinding wheel clamp
- 4 Rear grinding wheel clamp
- 5 Maintenance unit
- 6 Cam disc pressure

## 3.4.1 Switching the grinding machine on/off

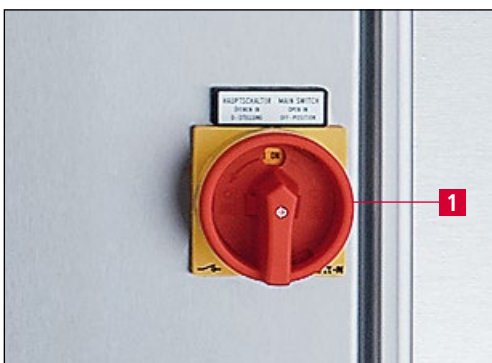

Figure 3-6 Main switch

- 1 Main switch

Turning the main switch to position "1 ON" the grinding machine is switched ready for operation.

Turning the main switch to position "0 OFF" the grinding machine is switched off.

# 3. Description

---

## 3.4.2 Control panel



- 1 Touch panel
- 2 "Emergency Stop" button
- 3 "Control ON" button
- 4 "Start/Stop" button
- 5 "Setting Mode" key switch: Position "1" for setting mode, Position "0" for automatic mode

Figure 3-7 Control panel

# 3. Description

## 3.4.3 Layout of user interface (main screen)

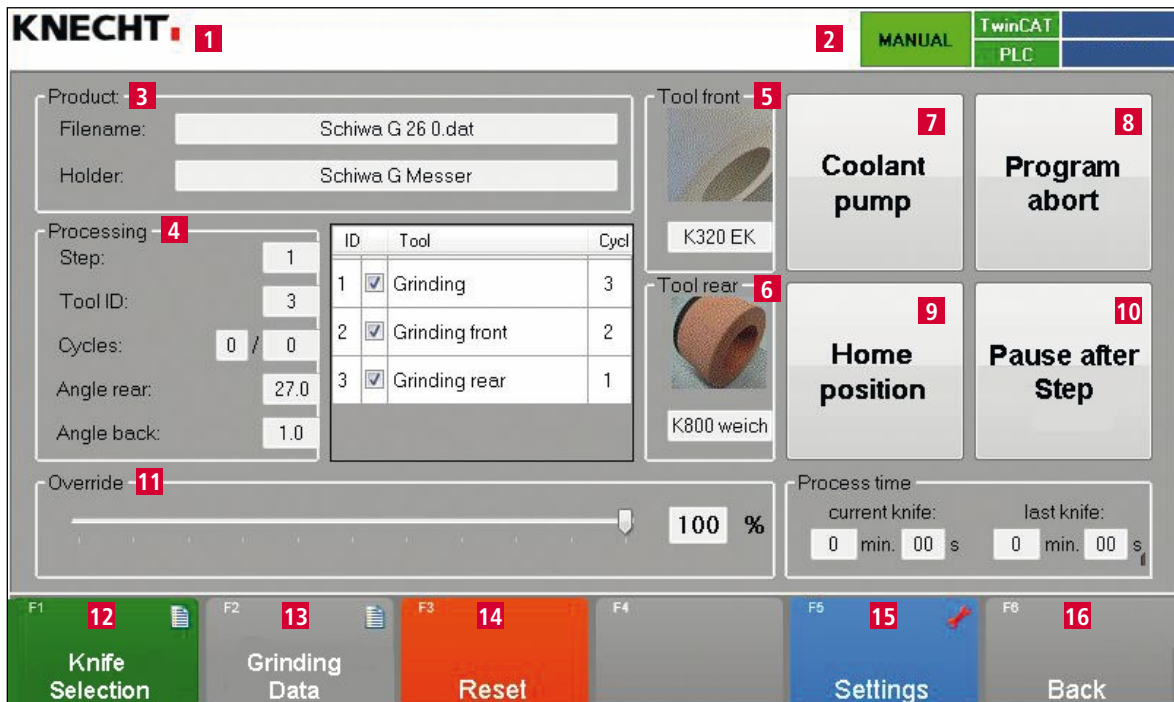

Figure 3-8 Main screen

- 1 Error messages
- 2 Status display
- 3 Product data (loaded grinding program)
- 4 Current processing step settings (stored in grinding program)
- 5 Tool front (front grinding wheel)
- 6 Tool rear (rear grinding wheel)
- 7 Coolant pump (switch coolant pump on/off)
- 8 Program abort (resets program after stop)
- 9 Home position (move grinding wheel to change position)
- 10 Pause after Step (program stops after current step)
- 11 Override (adapt speed to grinding disc)
- 12 **"F1 Knife Selection"**: select the desired grinding program, see Chapter 8.2
- 13 **"F2 Grinding Data"**: see Chapter 8.3
- 14 **"F3 Reset"**: delete current error
- 15 **"F5 Settings"**: see Chapter 8.4
- 16 **"F6 Back"**: return to previous screen

### NOTICE

The assignment of the touch panel buttons varies according to the current display screen. The respective assignment is indicated in text form.



## 4. Transport

---



**For transporting the machine, the locally applicable safety and accident prevention regulations must be observed.**

**Only transport the machine in the upright position (with the machine feet facing downwards).**

### 4.1 Transport aids

For transporting and for setting up the grinding machine, only use adequately dimensioned means of transport, e.g. truck, forklift or hydraulic lift truck. Remove the water bowl before transporting.

When using a forklift or a lift truck, move the fork under the grinding machine.

Bear in mind the center of gravity of the machine. The center of gravity (CoG) is shown in figure 3-1.

### 4.2 Transport damage

If damage is detected after unloading, during acceptance of the delivery, immediately inform KNECHT Maschinenbau GmbH and the forwarding agent. If necessary, an independent expert must be called in immediately.

Remove packaging and fastening straps. Dispose of packaging in an environmentally-friendly manner.

### 4.3 Transport to another installation site

For transport to another installation site, ensure that the space requirements are fulfilled (see Chapter 3.2).

A permitted electrical connection, pneumatic connection and network connection must be available at the new installation site. The grinding machine must stand firmly and securely.



**Installations on the electrical system may only be performed by an authorized specialist or our customer service staff. Observe the locally applicable safety and accident prevention regulations.**

# 5. Installation

---

## 5.1 Selection of qualified personnel



We recommend having the grinding machine installed by trained KNECHT personnel.

We assume no liability for damage caused by improper installation.

## 5.2 Installation site

When determining the installation site, bear in mind the space required for installation, maintenance and repair work on the grinding machine (see Chapter 3.2). The machine may only be stored or operated in dry rooms.

## 5.3 Supply connections

The grinding machine is provided ready to connect with the corresponding connection cable.

The power supply must be installed on site by a qualified electrician.

The compressed air supply and the network connection must be installed on site by a qualified technician.



Connect compressed air only when the doors are closed.

Never cut off the compressed air while the knives are clamped. This can result in serious injuries.

## 5.4 Settings

The various components and the electrical system are adjusted by KNECHT Maschinenbau GmbH prior to delivery.

**ATTENTION**

Unauthorized changes to set values are not permitted and may damage the grinding machine



# 5. Installation

---

## 5.5 Using the grinding machine for the first time

Place the grinding machine at the installation site on a level base.

Level out any floor unevenness by adjusting the machine feet (see Chapter 3.4, Figure 3-2/7) using a flat wrench (SW 17 mm). Check the machine for correct horizontal and vertical positioning by laying an appropriate machine water level on the respective guide rails.

Dismantle all the handling devices on the machine. Ensure that all the axes can be moved freely.

Completely install and check the safety devices before commissioning.



CAUTION

**Be sure to have all the safety devices checked by trained personnel before commissioning.**

## 6. Commissioning



All work on the machine may only be performed by trained personnel.

The locally applicable safety and accident prevention regulations must be observed.

Connect compressed air only when the doors are closed.

Never cut off the compressed air while the knives are clamped.  
This can result in serious injury.

Fill the water basin (3-2/3) to 3 cm below the rim with water.

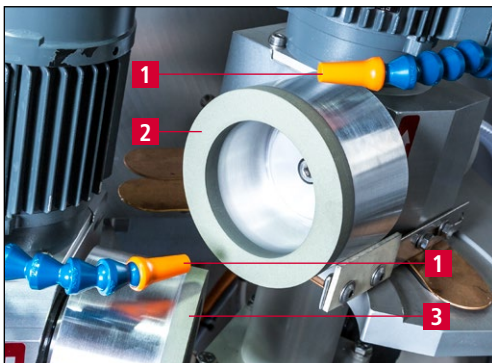

Figure 6-1 Set coolant hoses

Open the safety doors.

Set the coolant hoses (6-1/1) as illustrated in the figure. The gap from the rear grinding wheel (6-1/2) and the front grinding wheel (6-1/3) should be approx. 5 cm. The coolant hoses must not come into contact with the grinding wheels.

### ATTENTION

Observe the minimum gap between the coolant hoses and the grinding wheels, as the grinding wheel moves forward when grinding.

Connect the power plug to the socket provided on site (3x 400 V, 32 A).

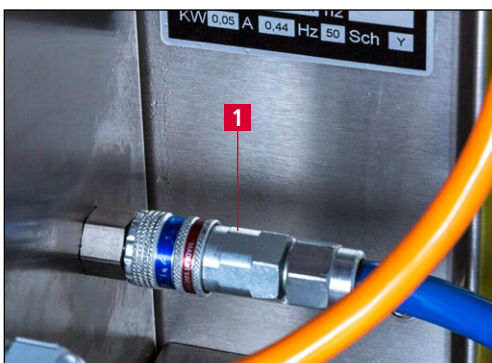

Figure 6-2 Compressed air connection

Plug in the compressed air hose at the compressed air port (6-2/1).

Close the safety doors.

## 6. Commissioning

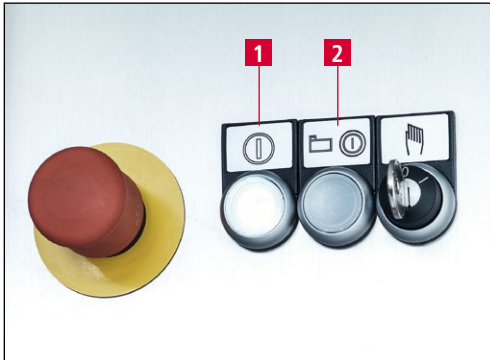

Figure 6-3 Control panel

Set the main switch (3-6/1) to "I". Wait for the controls to initialize.

Switch on the control unit with the "Control ON" button (6-3/1) when the "Control ON" button (6-3/1) starts flashing.

### ATTENTION

**Under no circumstances may the grinding program be activated using the "Start/Stop" button (6-3/2).**

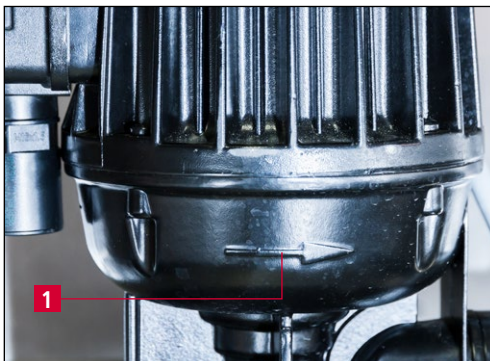

Figure 6-4 Check direction of rotation

Check the direction of rotation of the coolant pump.

The direction arrow (6-4/1) indicates the direction of rotation of the coolant pump.

If required, interchange the phases in the power plug

### ATTENTION

**Make sure the machine is correctly connected to the power supply.**

**If the connection to the voltage supply is incorrect, the grinding belts and cam disc can rotate in opposite direction of the prescribed direction. Incorrect direction of rotation can result in serious injuries.**

# 7. Operation



All work on the machine may only be performed by trained personnel.

The locally applicable safety and accident prevention regulations must be observed.

Never mount the knife without blade guard. This can result in serious injury.

## 7.1 Switch on the grinding machine

Set the main switch (3-6/1) to "I". Wait for the controls to initialize. The main screen (3-8) appears and the "Control ON" button (3-7/3) flashes.

Press "Control ON" button (3-7/3), then turn key switch (3-7/5) to the "0" position (automatic mode).

## 7.2 Grind knives

### 7.2.1 Load grinding program

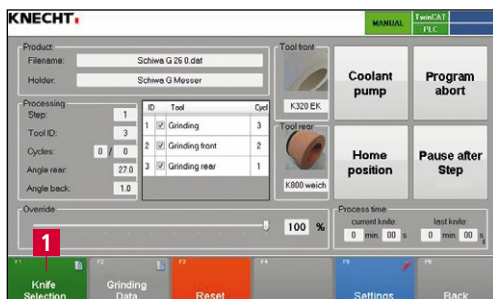

Figure 7-1 Main screen

Press the touch panel button "F1 Knife Selection" (7-1/1) on the main screen. The dialog box for menu item "Open" appears. The grinding programs are located in the "Product Data" folder.

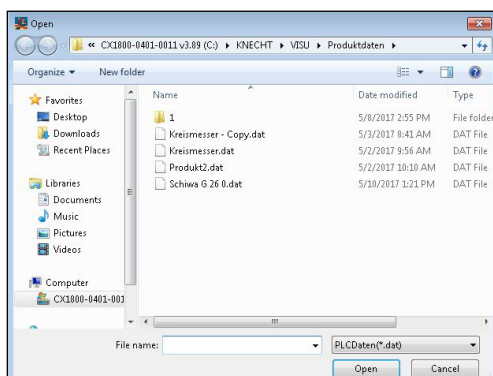

Figure 7-2 Select grinding program

Then select the desired grinding program by double clicking on the respective file. (grinding programs have the ending ".dat" in the file name).

The grinding program is now loaded and the "Open" dialog closes.

# 7. Operation

## ATTENTION

Use the grinding program that matches the knife. An incorrect grinding program can damage the machine and knife.

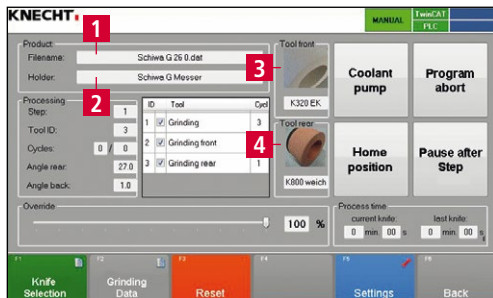

Figure 7-3 Main screen

The selected grinding program appears on the main screen in the "Filename" line (7-3/1).

Check the abrasives used (7-3/3) and (7-2/4) and change as necessary.

The images and data must match the abrasives used.

## NOTICE

The name of the grinding wheel matching the grinding program appears on the main screen under "Holder" (7-3/2). This name is engraved on the cam disc.

The appropriate abrasive must be used for each knife and grinding program.

### 7.2.2 Mount cam disc SP 116



Figure 7-4 Mount Z coupling

Open the safety doors.

Mount the Z coupling on cam disc SP 116 as described and tighten using combination wrench SW 19 mm. Here, care should be taken to note the relevant marking on the Z coupling and the base plate.

# 7. Operation

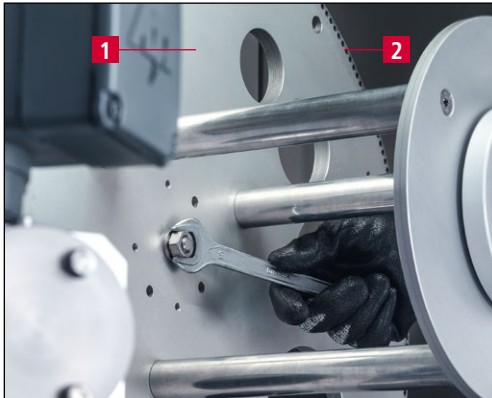

Figure 7-5 Mount cam disc SP 116

Insert cam disc SP 116 (7-5/1) in the bracket (3-4/3) and tighten with wrench SW19.

Hand tighten the cam disc in such a way that the boreholes (7-5/2) are oriented in the direction of the grinding wheels.

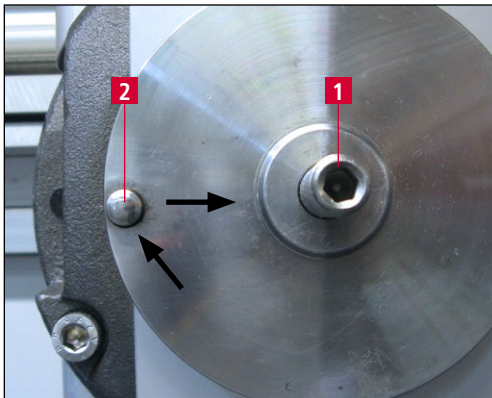

Figure 7-6 Spigot and centering pin

The spigot (7-6/1) and centering pin (7-6/2) must engage appropriately in the cam disc.

**ATTENTION**

**Incorrect positioning of cam disc SP 116 can damage the limit switches and the drive pinion**

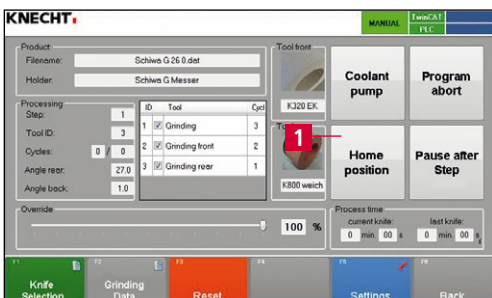

Figure 7-7 Move cam disc into change position

Close the safety doors.

Press "Home position" (7-7/1) on the touch panel in the main menu to move the cam disc into the change position.

The cam disc moves to a position suitable for placing of knives.

## 7. Operation

---

### **ATTENTION**

Depending upon the size and dimension of the knife, the knife can be unwieldy with a blade guard. → Ergonomics.

Do not step inside the machine room in order to insert the knife.

# 7. Operation

## 7.2.3 Grind the slicer knife without suspension attachment

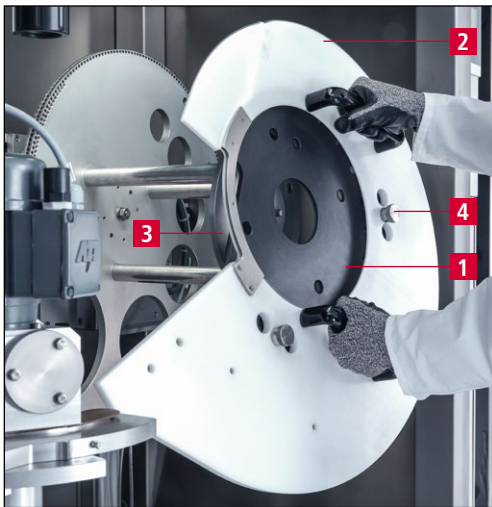

Figure 7-8 Place knife

Open the safety doors.

Place the knife (7-8/1) with blade guard (7-8/2) on the spigot (7-8/3) and align with the relevant centering device (7-8/4).

The contour of the cam disc corresponds to the contour of the knife.



**Never place the knife without blade guard.**

**This can result in serious injuries.**

### ATTENTION

**Only use knives suitable for the cam disc (compare label on disc and knife).**

**Using an incorrect cam disc can damage the knife and machine**

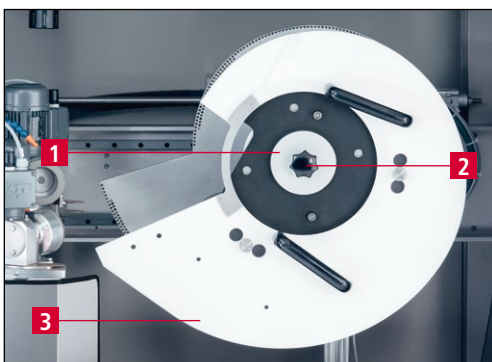

Figure 7-9 Clamp knife

Secure the knife and blade guard from falling (7-9/3) with one hand and attach the clamping flange (7-9/1); mount the star handle (7-9/2) with the other hand.

Tighten the star handle (7-9/2). Finally, remove the blade guard (7-9/3).

Close the safety doors.



# 7. Operation

---



Sharp knife edge, can result in serious injuries.

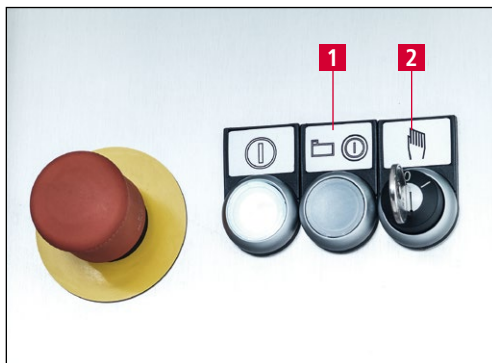

Figure 7-10 Control panel

Turn the “Setup Mode” key switch (7-10/2) to “0” and press the “Start/Stop” button (7-10/1).

Open the coolant tap.

The machine starts the grinding process.

When the knife is in working position, press the “Start/Stop” button (7-10/1) again to stop the machine.

## NOTICE

**If you briefly press the “Start/Stop” button, the program is interrupted and the button flashes. The grinding program continues when the button is pressed again.**

**Pressing the “Start/Stop” button for 3 seconds aborts the program. The button no longer flashes. Pressing the button again starts the program flow once more from the beginning.**

# 7. Operation

## 7.2.4 Grinding the slicer knife with suspension attachment

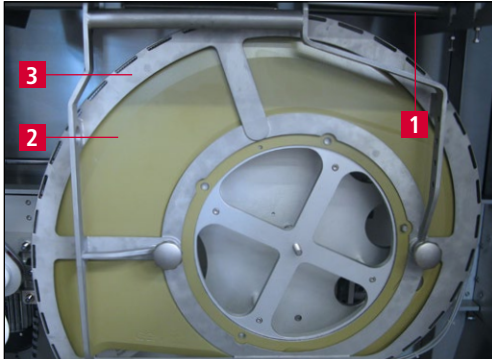

Figure 7-11 Suspension attachment

Open the safety doors.

Place the knife (7-11/2) including blade guard (7-11/3) on the respective suspension attachment (7-11/1). Place the knife (7-11/2) with guard (7-11/3) on the spigot (7-12/1).

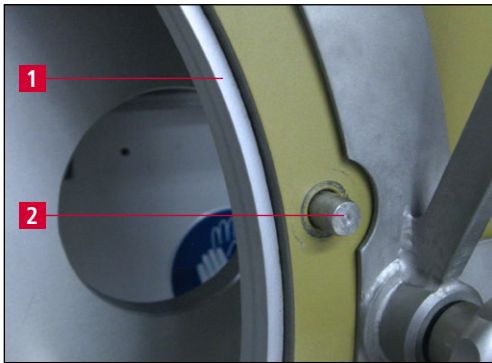

Figure 7-12 Centering device

Align using the centering device (7-12/2).

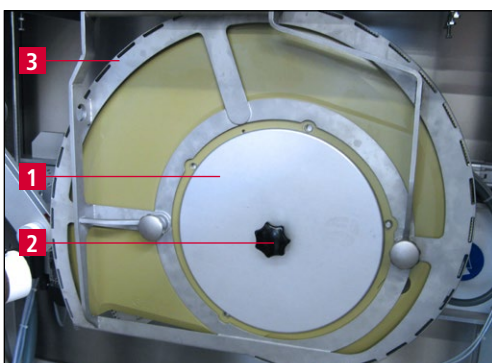

Figure 7-13 Suspension attachment

The contour of the cam disc corresponds to the contour of the knife.

Secure the knife and blade guard from falling (7-13/3) with one hand and attach the clamping flange (7-13/1); mount the star handle (7-13/2) with the other hand. Tighten the star handle (7-13/2). Finally, remove the blade guard (7-13/3).

**ATTENTION**

**Only use a knife that is suitable for the cam disc (compare label on disc and knife).**

**Using an incorrect cam disc can damage the knife and machine.**

## 7. Operation

---

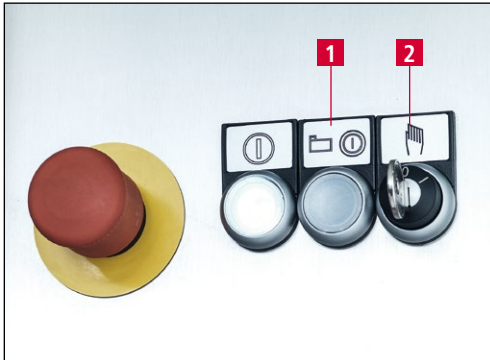

Figure 7-14 Control panel

### NOTICE

Close the safety doors.

Turn the "Setup Mode" key switch (7-14/2) to "0" and press the "Start/Stop" button (7-14/1).

Open the coolant tap.

The machine starts the grinding process.

When the knife is in working position, press the "Start/Stop" button (7-14/1) again to stop the machine.

**If you briefly press the "Start/Stop" button, the program is interrupted and the button flashes. The grinding program continues when the button is pressed again.**

**Pressing the "Start/Stop" button for 3 seconds aborts the program. The button no longer flashes. Pressing the button again starts the program flow once more from the beginning.**

# 7. Operation

## 7.2.5 Grind circular knives

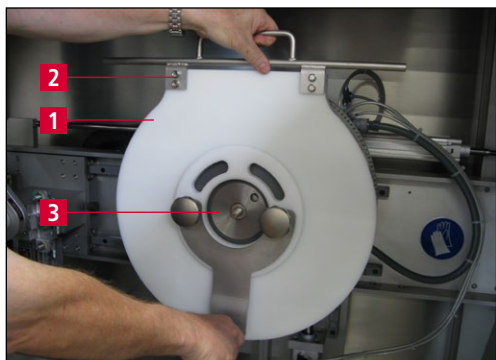

Figure 7-15 Place circular knife

Open the safety doors.

Place the knife (concealed in a blade guard (7-15/1)) with guard (7-15/2) on the spigot (7-15/3).

The contour of the cam disc corresponds to the contour of the knife.

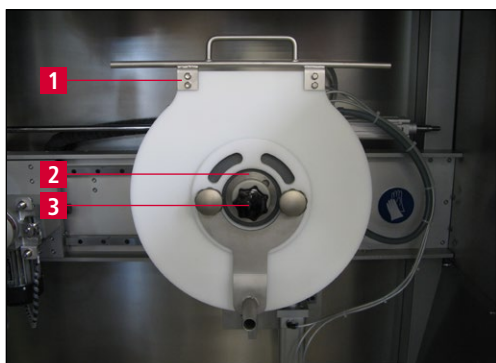

Figure 7-16 Circular knife

Secure the knife and blade guard from falling (7-16/1) with one hand and attach the clamping flange (7-16/2); mount the star handle (7-16/3) with the other hand.

Tighten the star handle (7-16/3). Finally, remove the blade guard (7-16/1).

Close the safety doors.

### ATTENTION

**Only use a knife that is suitable for the cam disc (compare label on disc and knife).**

**Using an incorrect cam disc can damage the knife and machine.**

## 7. Operation

---

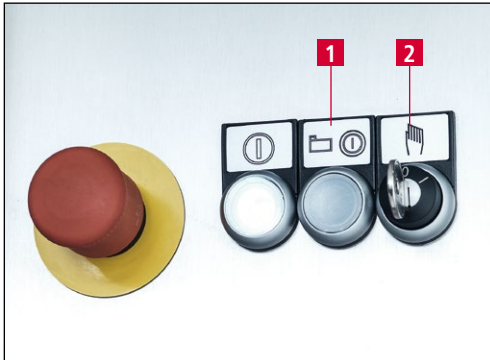

Figure 7-17 Control panel

### NOTICE

Turn the "Setup Mode" key switch (7-17/2) to "0" and press the "Start/Stop" button (7-17/1).

Open the coolant tap.

The machine starts the grinding process.

When the knife is in working position, press the "Start/Stop" button (7-17/1) again to stop the machine.

**If you briefly press the "Start/Stop" button, the program is interrupted and the button flashes. The grinding program continues when the button is pressed again.**

**Pressing the "Start/Stop" button for 3 seconds aborts the program. The button no longer flashes. Pressing the button again starts the program flow once more from the beginning.**

# 7. Operation

---

## 7.2.6 Set the knife at the center of the disc

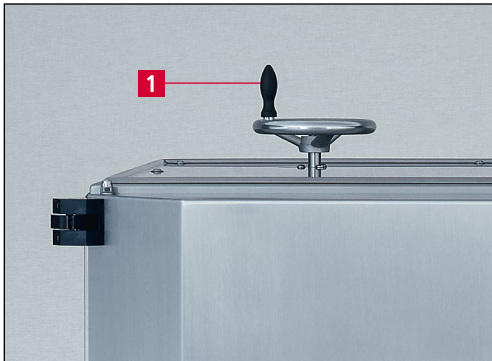

**Figure 7-18** Set knife

Adjust the knife with the hand wheel (7-18/1) in such a way that the knife edge passes through the center of the rear grinding wheel.

Check sharpness when the program ends ("Start/Stop" button no longer flashes).

If the knife is not yet sharp, mark the blade on both sides with a pencil and grind again.

The marked places indicate whether the knife has been completely ground or not. If not, adjust the grinding angle to make it steeper

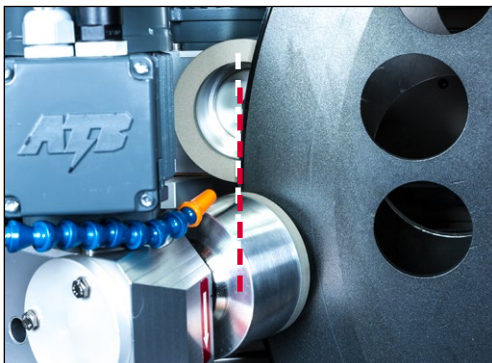

**Figure 7-19** Right

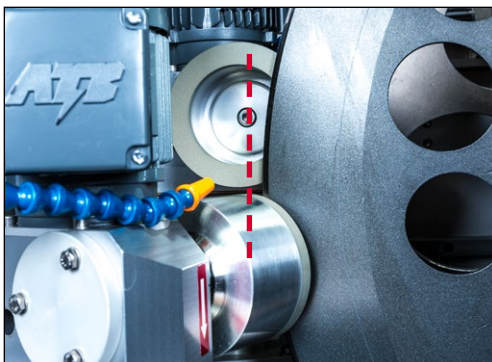

**Figure 7-20** Wrong

# 7. Operation



There is a risk of clothing and hair getting entangled. There is a risk of hands being crushed. This can result in serious injury.

To prevent dust formation, always have the coolant tap on while dressing and direct the coolant hose at the grinding wheels.

Never dress with mounted knives.

This can result in serious cut injuries.

## 7.3 Dressing the front/rear grinding wheel

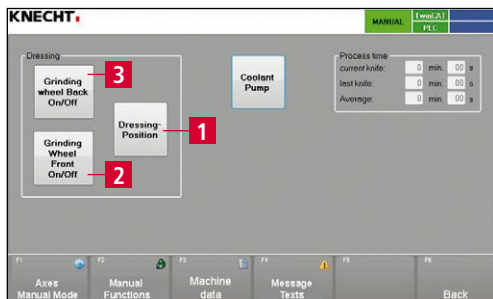

Figure 7-21 Settings

If the front grinding wheel is running out of true or is loaded, it must be dressed.

Close the safety doors.

Change to settings via the main menu "F5 Settings" (3-8/15). Press "Dressing Position" (7-21/1) on the touch panel to move the grinding wheels into dressing position.

### ATTENTION

Turn the "Setup Mode" key switch (3-7/5) to position "1".

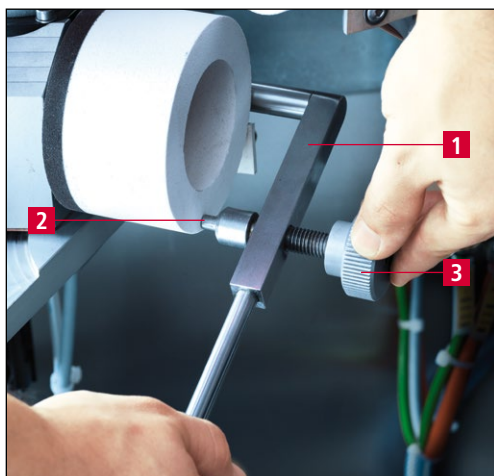

Figure 7-22 Dress front grinding wheel

Open the safety doors.

Switch on the front grinding wheel. To do so, press "Grinding wheel front On/Off" (7-21/2) on the touch panel.

Insert the deburring lever (7-22/1) as far as it will go into the relevant bushing. Move the dressing diamond (7-22/2) with the deburring lever evenly over the grinding wheel, which is switched on. The dressing diamond is fed by rotating the feed nut (7-22/3) in clockwise direction.

## 7. Operation

---

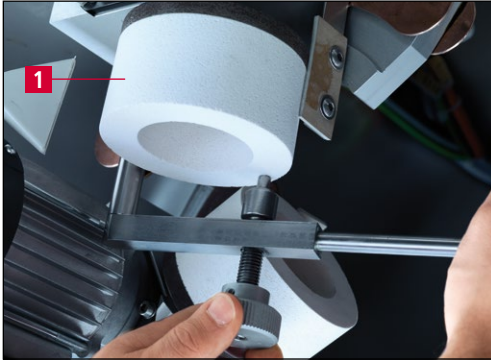

**Figure 7-23** Dress rear grinding wheel

Switch on the rear grinding wheel (7-23/1) by pressing "Grinding wheel rear On/Off" (7-21/3) on the touch panel and carry out dressing as described above.



# 7. Operation

## 7.4 Changing the front/rear grinding wheels

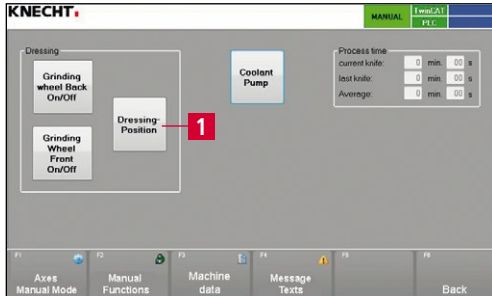

Figure 7-24 Settings

Close the safety doors.

Change to settings via the main menu "F5 Settings" (3-8/15). Move the grinding wheels into dressing position by pressing "Dressing Position" (7-24/1) on the touch panel

Open the safety doors.



Turn the "Setup Mode" key switch (3-7/5) to position "1".

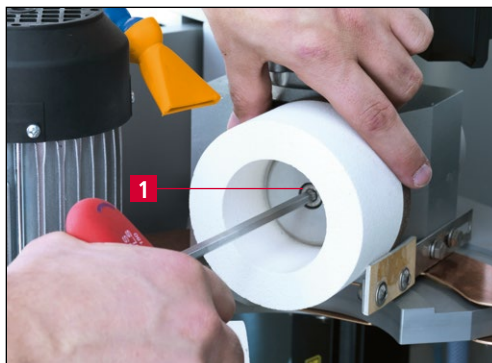

Figure 7-25 Change grinding wheels

Use SW6 Allen wrench to loosen and remove the screw at the center of the grinding wheel (7-25/1) by turning it counter-clockwise.

Remove the front or rear grinding wheel and also the connection flange (7-26/1) if necessary and mount the new grinding wheel in the reverse order.



Figure 7-26 Connection flange

If the grinding wheel is half-worn, mount the connection flange (7-26/1) with an M8x40 screw.



Two connection flanges with corresponding screws are included in the accessories.

## 7. Operation

---

### **ATTENTION**

Only original abrasives from KNECHT Maschinenbau GmbH are permitted to be used.

KNECHT Maschinenbau GmbH assumes no responsibility for the use of non-original abrasives.

# 7. Operation

---

## 7.5 Adjusting the grinding angle



The grinding angle of the grinding wheels, is adjusted based on the parameters in the grinding program (see Chapter 8.3.3)

**Figure 7-27** Adjust grinding wheel

# 8. Control system

## 8.1 Main screen

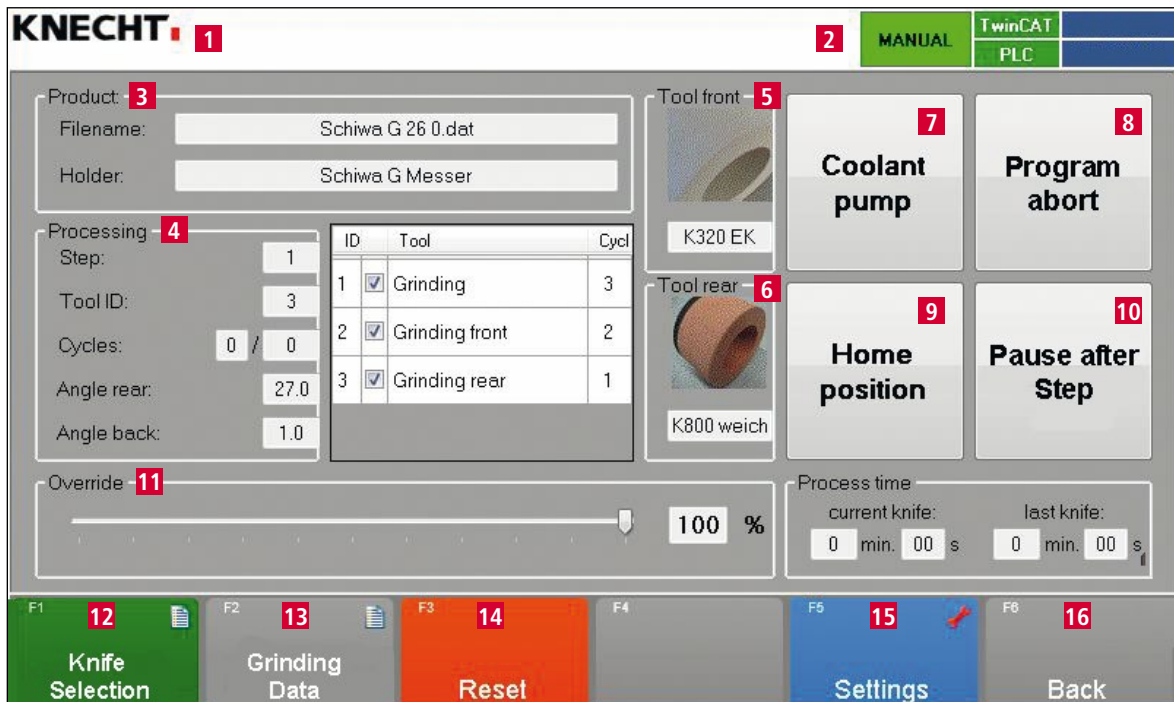

Figure 8-1 Main screen

- 1 Error messages
- 2 Status display
- 3 Product data (loaded grinding program)
- 4 Current processing step settings ( stored in grinding program)
- 5 Tool front (front grinding wheel)
- 6 Tool rear (rear grinding wheel)
- 7 Coolant pump (switch coolant pump on/off)
- 8 Program abort (resets program after stop)
- 9 Home position (move grinding wheel to change position)
- 10 Pause after Step (program stops after current step)
- 11 Override (adapt speed to grinding disc)
- 12 **"F1 Knife Selection"**: select the desired grinding program, see Chapter 8.2
- 13 **"F2 Grinding Data"**: see Chapter 8.3
- 14 **"F3 Reset"**: delete current error
- 15 **"F5 Settings"**: see Chapter 8.4
- 16 **"F6 Back"**: return to previous screen

### NOTICE

The assignment of the touch panel buttons varies according to the current display screen. The respective assignment is indicated in text form.

# 8. Control system

## 8.2 Grinding program

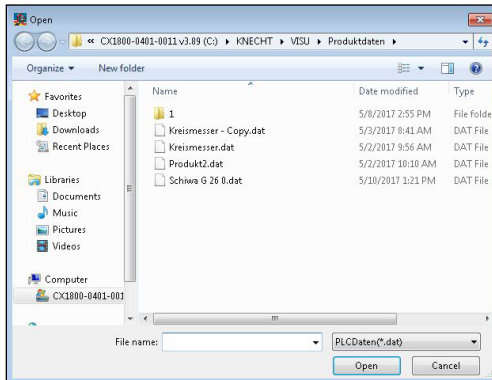

**Figure 8-2** Select grinding program

Press "F1 Knife Selection" (8-1/12) on the main screen.

The "Open" dialog box (8-2) from Windows appears. The directory C:\Product is automatically displayed. The grinding programs for the individual knives are filed in this folder. The grinding programs have the ending ".dat" in the file name.

To load a grinding program, proceed as follows: Select the desired grinding program. The name of the selected grinding program appears in the File Name column. The grinding program is loaded with one click on the "Open" button.

The "Open" dialog box is closed and the selected grinding program is displayed in the main menu.

# 8. Control system

## 8.3 Grinding data

The data for the grinding process are entered via the main menu "F2 Grinding Data" (8-1/13). These data vary according to the knife. The data are saved in a file and can be loaded again from the file.

### ATTENTION

Changing the grinding data can cause malfunction and damage to the machine. Changes may only be made under the supervision of KNECHT technicians or by persons who have been trained by KNECHT Maschinenbau.

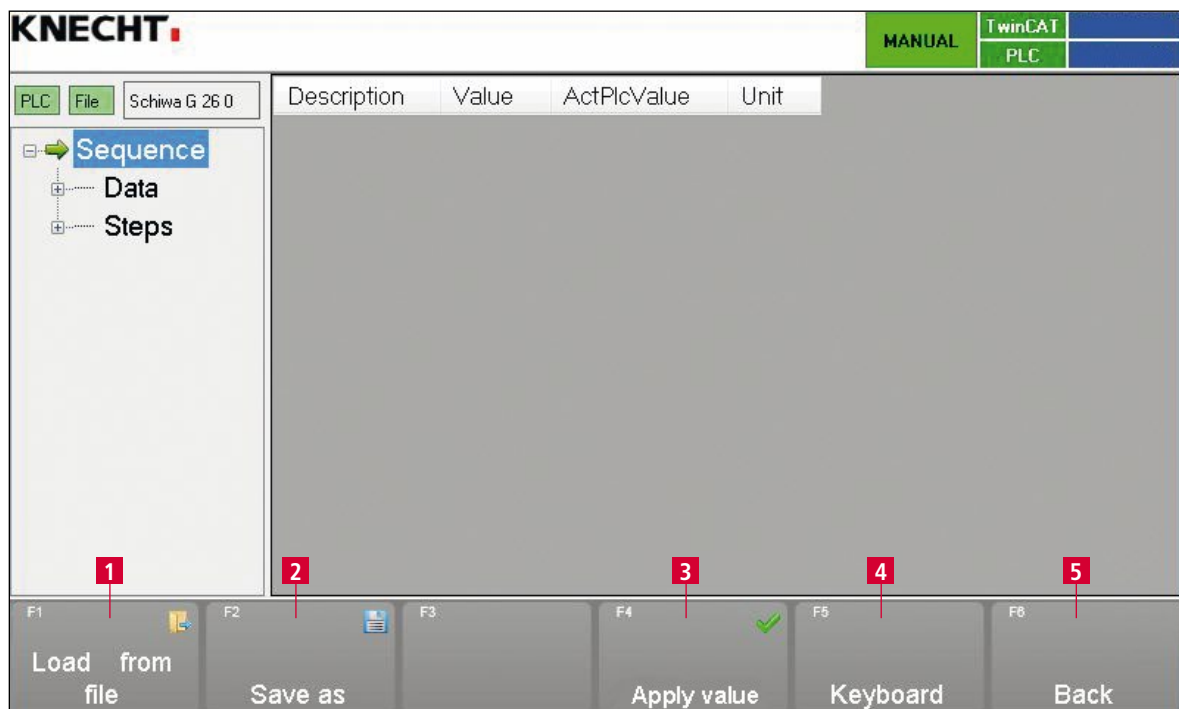

Figure 8-3 Grinding data

- 1 "F1 Load from file"
- 2 "F2 Save as"
- 3 "F4 Apply value"
- 4 "F5 Keyboard"
- 5 "F6 Back": return to previous screen

# 8. Control system

## 8.3.1 Data

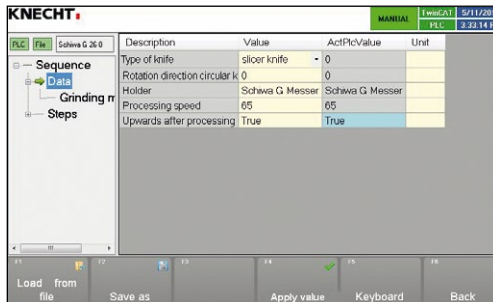

Figure 8-4 Grinding data "Data"

**Type of knife:** circular/sickle knife

**Rotation direction circular knife:** 0 = left, 1 = right

**Holder:** index as to which holder will be used for processing the knife

**Processing speed:** processing speed at which the cam disc rotates during the grinding process (mm/s)

**Upwards after processing:** true = yes, false = no (for better assembly or assembly with suspension protection)

## 8.3.2 Abrasives

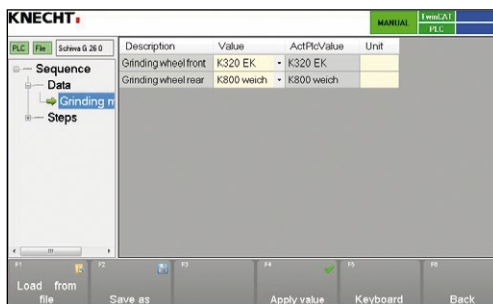

Figure 8-5 Grinding data "Abrasives"

**Grinding wheel front**

**Grinding wheel rear**

## 8.3.3 Steps

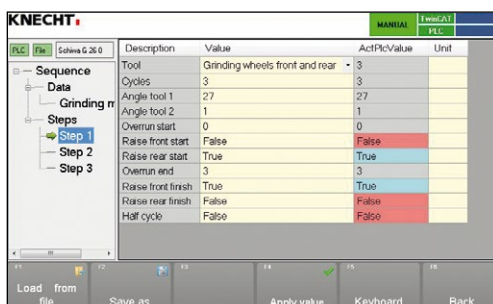

Figure 8-6 Grinding data "Steps"

**Tool:** selection of the abrasives

**Cycles:** number 1, 2, 3

**Angle Tool 1 (front):** angle adjustment of front grinding wheel

**Angle Tool 2 (rear):** angle adjustment of rear grinding wheel

**Overrun start:** distance limit switch is reached

**Raise front start:** front grinding wheel is raised, true = yes, false = no

**Raise rear start:** rear grinding wheel is raised, true = yes, false = no

**Overrun end:** distance limit switch is reached

**Raise front finish:** front grinding wheel is raised from knife, true = yes, false = no

## 8. Control system

---

**Raise rear finish:** rear grinding wheel is raised from knife, true = yes, false = no

**Half cycle:** tool only does half cycle



# 8. Control system

## 8.4 Settings

Machine settings other than the basic functions of "Start" or "Stop" are applied using the "F5 Settings" main menu (8-1/15).

**ATTENTION**

Changing the settings can damage the machine.

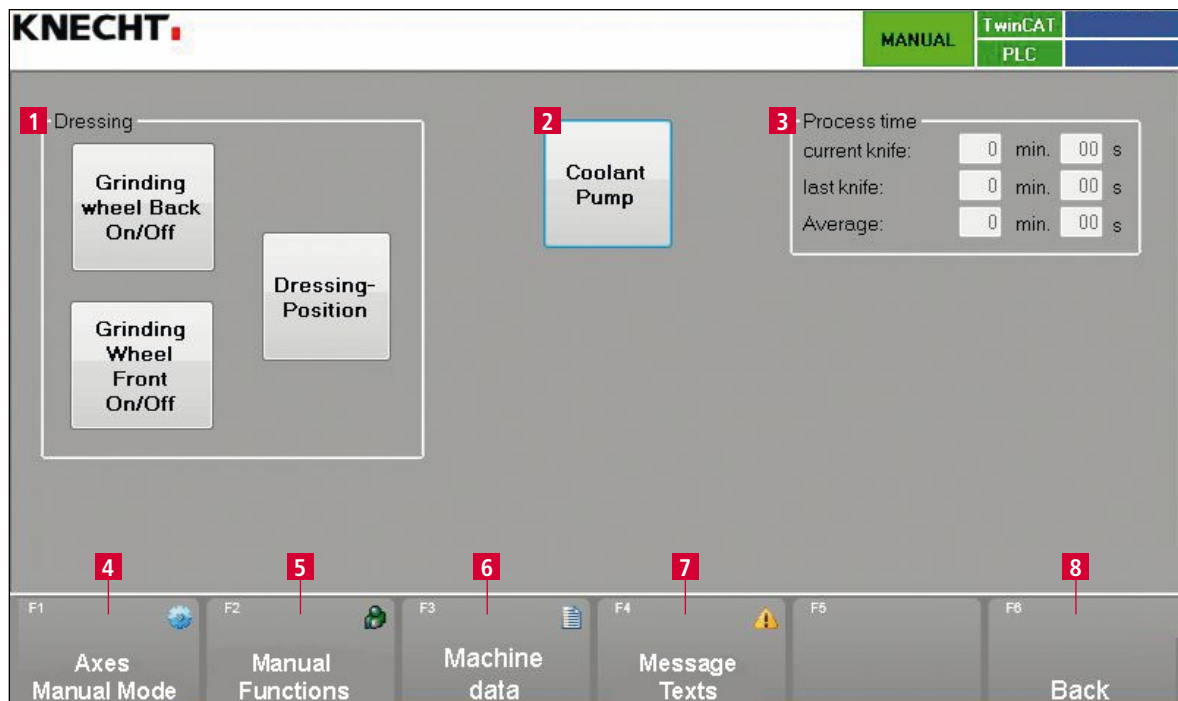

Figure 8-7 Settings

- 1 Dressing (switch grinding wheels on/off or move into dressing position)
- 2 Coolant pump (switch on/off)
- 3 Processing time (current knife, last knife and average in min/secs)
- 4 **"F1 Axes Manual Mode"**: axes are moved individually in manual mode
- 5 **"F2 Manual Functions"**: allows manual operation of the machine
- 6 **"F3 Machine Data"**: for displaying/editing machine data that has been set ex-factory
- 7 **"F4 Message Texts"**: display all error messages sequentially (number of messages, frequency, start)
- 8 **"F6 Back"**: return to previous screen

# 8. Control system

## 8.5 Axes in manual mode

Access the sub-menu "F1 Axes Manual Mode" (8-7/4) via the main menu "F5 Settings" (8-1/15). The "Axes Manual Mode" (8-8) display screen shows the status of the CNC driven machine axes. The axes can also be controlled manually. The individual axis positions are displayed at the top left of the sub-menu "Axes Manual Mode".

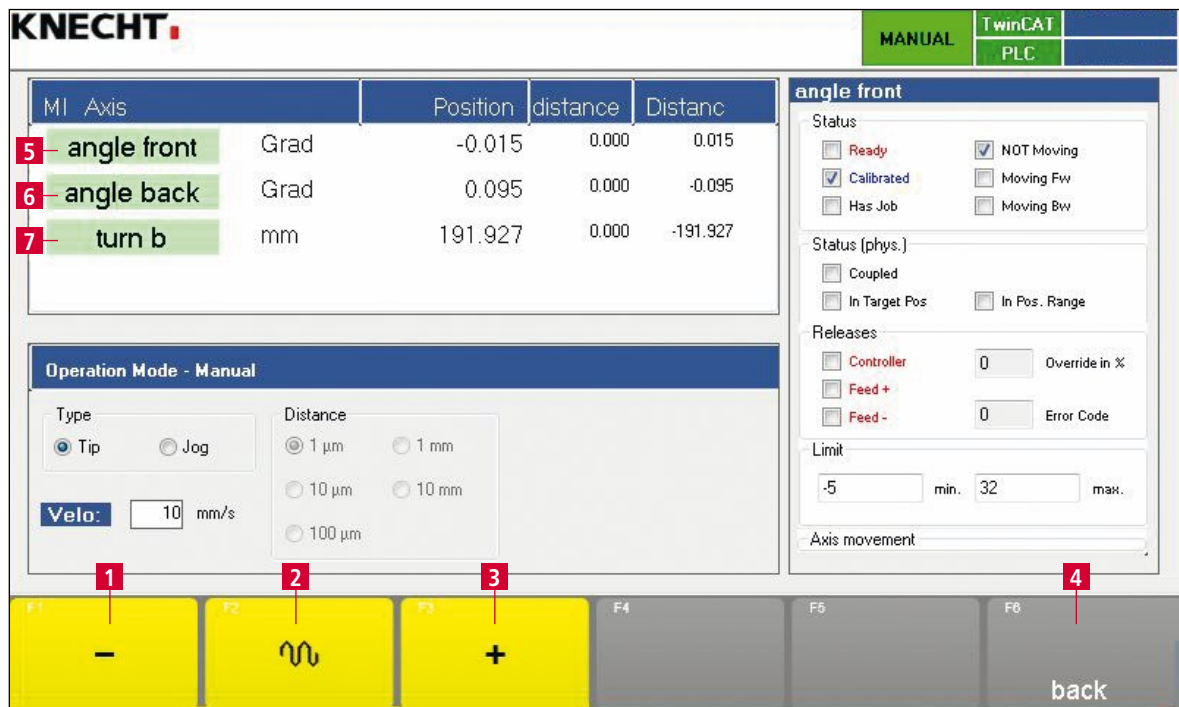

Figure 8-8 Settings "Axes Manual Mode"

- 1 "-" : move the selected axes in "-" direction (backwards)
- 2 "~" : activate rapid traverse in the respective direction in combination with "-" or "+"
- 3 "+" : move the selected axes in "+" direction (forwards)
- 4 "F6 Back" : return to previous screen

## 8. Control system

---



**Figure 8-9** Angle of grinding wheels

The angle movement of the front grinding wheel is designated "angle front" (8-8/5), that of the rear grinding wheel is "angle back" (8-8/6).

In order to move the axes manually, select the desired axis on the touch panel. The selected axis is highlighted in blue.

The axes can be moved by means of "-" (8-8/1), "+" (8-8/3) and "~" (8-8/2).

# 8. Control system

## 8.6 Manual functions

The manual functions allow you to operate the machine by hand. They can be accessed via the main menu "F5 Settings" (8-1/15) followed by "F2 Manual Functions" (8-7/5). Various functions of the machine can be individually enabled.

### ATTENTION

Buttons highlighted in green are enabled.  
Buttons highlighted in gray are disabled.

### NOTICE

Manual functions are not required in normal operation. During maintenance work (e.g. when changing grinding wheels), the individual machine components can be moved to a more easily accessible position using the manual functions.

### 8.6.1 General

When the sub-menu "F2 Manual Functions" (8-7/5) is accessed, the screen initially switches to the general manual functions (8-10).

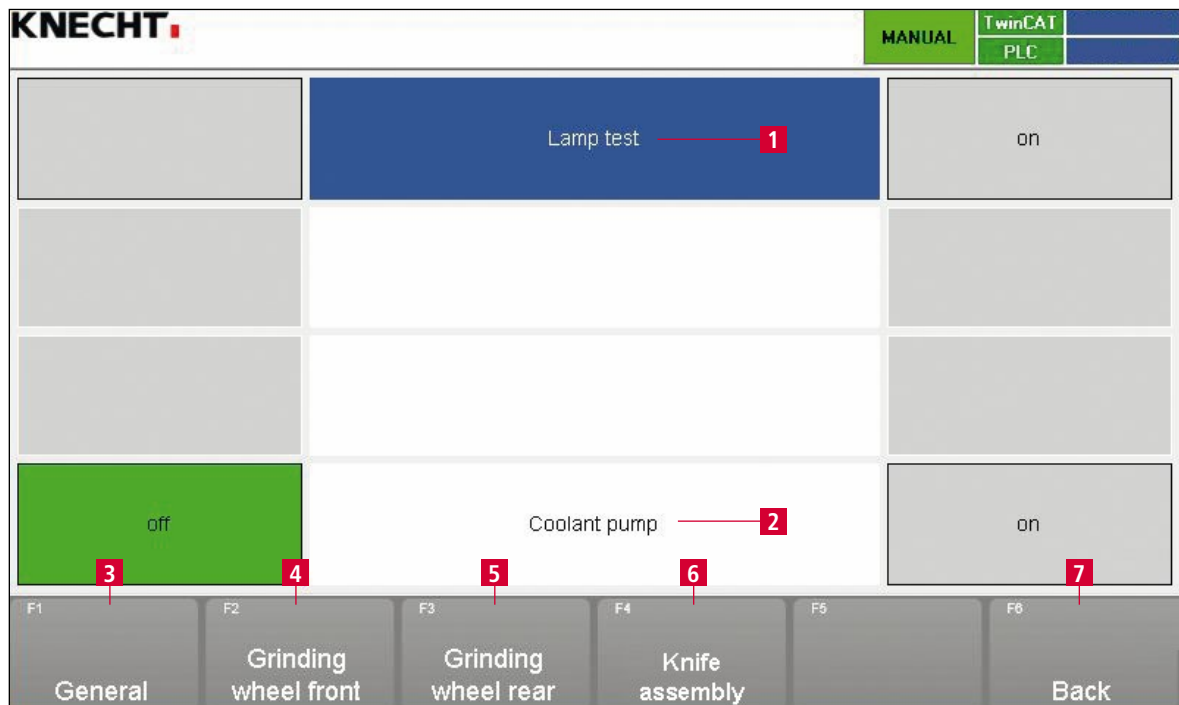

Figure 8-10 Manual functions "General"

- 1 Switch on lamp test
- 2 Switch coolant pump on/off
- 3 "F1 General" (current display)

# 8. Control system

- 4 "F2 Grinding wheel front": see Chapter 8.6.2
- 5 "F3 Grinding wheel rear": see Chapter 8.6.3
- 6 "F4 Knife assembly": see Chapter 8.6.4
- 7 "F6 Back": return to previous screen

## 8.6.2 Grinding wheel front

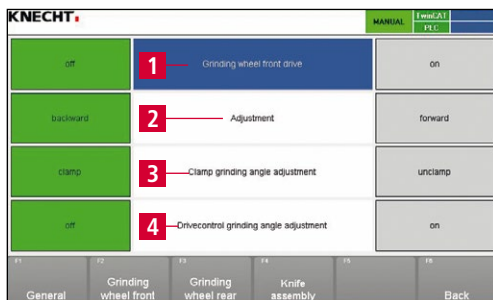

Figure 8-11 Manual functions "Grinding wheel front"

- 1 Switch on/off front grinding wheel drive
- 2 Move grinding wheel forwards/backwards
- 3 Clamp/release grinding angle adjustment
- 4 Switch on/off drivecontrol grinding angle adjustment

## 8.6.3 Grinding wheel rear

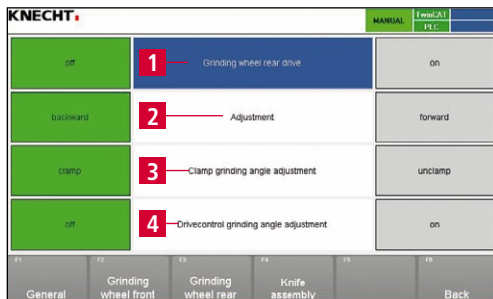

Figure 8-12 Manual functions "Grinding wheel rear"

- 1 Switch on/off rear grinding wheel drive
- 2 Move grinding wheel forwards/backwards
- 3 Clamp/release grinding angle adjustment
- 4 Switch on/off drivecontrol grinding angle adjustment

## 8.6.4 Knife assembly

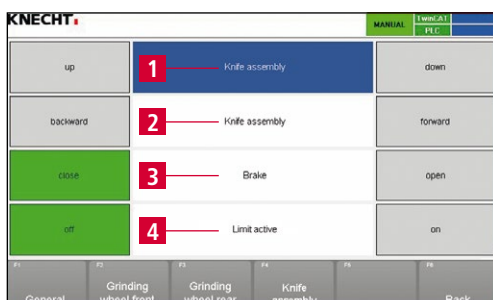

Figure 8-13 Manual functions "Knife assembly"

- 1 Move knife assembly up/down
- 2 Move knife assembly forwards/backwards
- 3 Open/close brake
- 4 Switch on/off limits (machine does not move beyond the limit switches in manual mode)

## 8. Control system

---

### **ATTENTION**

Only open the brake when the knife assembly has previously been moved away and forwards. Otherwise there is a risk of damage to the machine, since the cam disc can impact against the side wall in an uncontrolled manner.

# 8. Control system

## 8.7 Machine data

Access the sub-menu "F3 Machine data" (8-7/6) via the main menu "F5 Settings" (8-1/15). The "Machine data" display (8-14) shows the basic machine settings. The data are saved in a file and can be loaded again from the file.

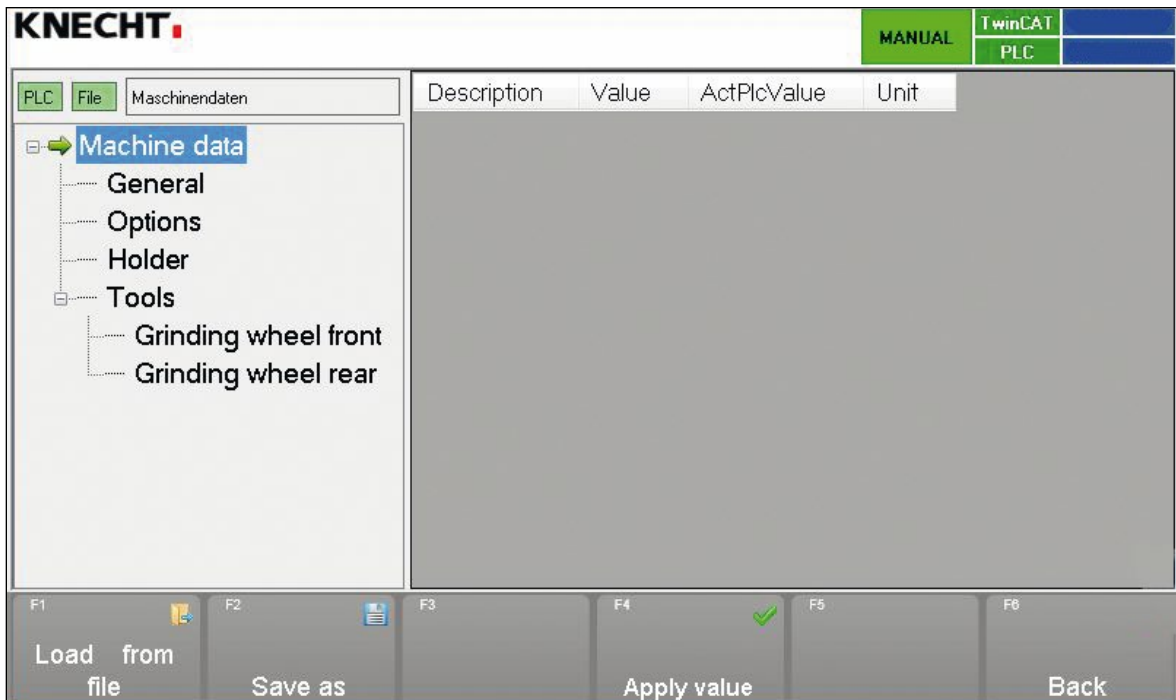

Figure 8-14 Machine data

- 1 "F1 Load from file"
- 2 "F2 Save as"
- 3 "F4 Apply value"
- 4 "F6 Back": return to previous screen

### 8.7.1 General

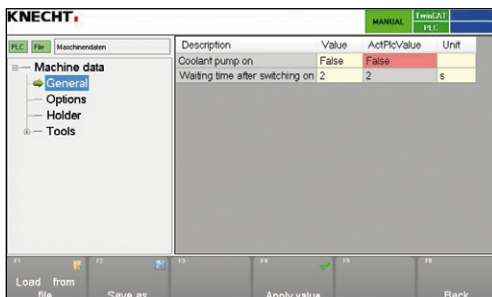

Figure 8-15 Machine data "General"

**Coolant pump on:** true = always on,  
false = only on at program start

**Waiting time after switching on coolant pump:** (in secs)

# 8. Control system

## 8.7.2 Options

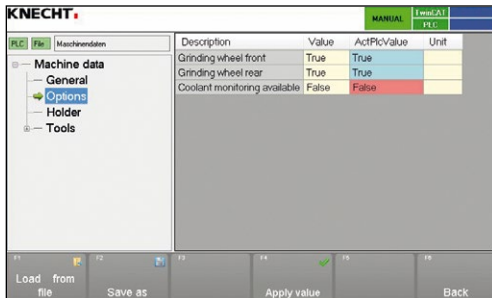

Figure 8-16 Machine data "Options"

**Grinding wheel front:** true = available, false = not available

**Grinding wheel rear:** true = available, false = not available

**Coolant monitoring available:** true = yes, false = no

## 8.7.3 Holder

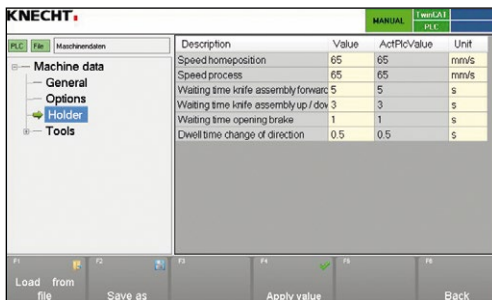

Figure 8-17 Machine data "Holder"

**Speed homeposition:** (mm/s)

**Speed process:** (mm/s)

**Waiting time knife assembly forward / backward:** (in secs)

**Waiting time knife assembly up / down:** (in secs)

**Waiting time opening brake:** (in secs)

**Dwell time change of direction:** (in secs)

## 8.7.4 Tools – Grinding wheel front/rear

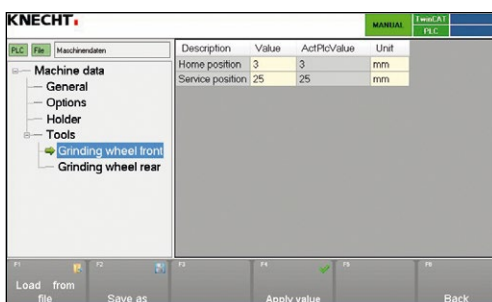

Figure 8-18 Machine data "Grinding wheel front/rear"

**Home position:** (in mm)

**Service position:** (in mm)



# 8. Control system

## 8.8 Message texts

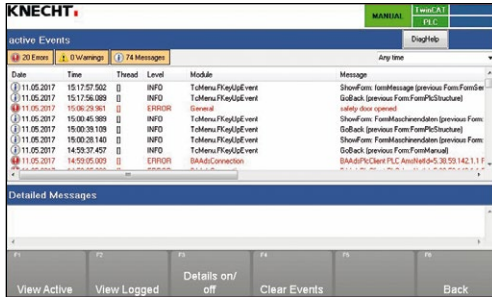

Figure 8-19 Message texts

The Message Texts screen (8-19) serves only to display the status messages of the machine in detail.

The Message Texts screen provides an overview of the number of errors that are hindering the operation of the machine at a particular moment. Furthermore, the sub-menu provides information as to which errors have occurred and since when they have been active.

### NOTICE

**No settings can be applied in the Message Texts sub-menu. The errors are also displayed in the top half of the main screen (8-1/1).**

# 8. Control system

## 8.9 Options



Figure 8-20 Main screen

Other options such as language settings can be accessed via the main menu.

Press "F6 Back" (8-20/1) on the touch panel to get back to the start screen.



Figure 8-21 Start screen

Press "F5 Options" (8-21/1) on the touch panel.

A new window (8-22) opens.

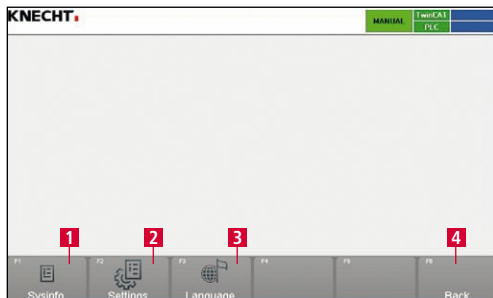

Figure 8-22 Options

- 1 "F1 Sysinfo"
- 2 "F2 Settings"
- 3 "F3 Language": change language
- 4 "F6 Back": return to previous screen

# 8. Control system

## 8.10 Language



Figure 8-23 Main screen

The user interface language can be changed to the language of the country of use. The parameter descriptions are always in English.

In the main menu, press "F6 Back" (8-23/1) on the touch panel to get back to the start screen.

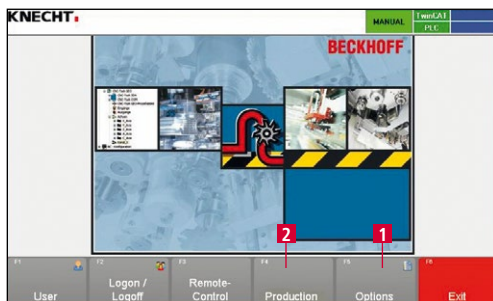

Figure 8-24 Start screen

Press "F5 Options" (8-24/1) on the touch panel.

A new window (8-25) opens.

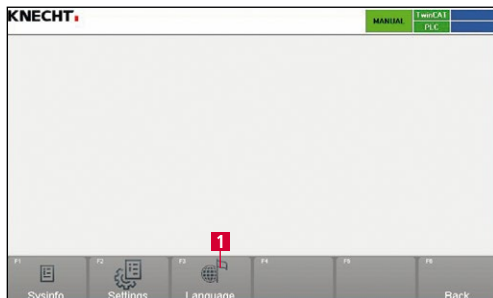

Figure 8-25 Options

Use "F3 Language" (8-25/1) to open the language selection (8-26).

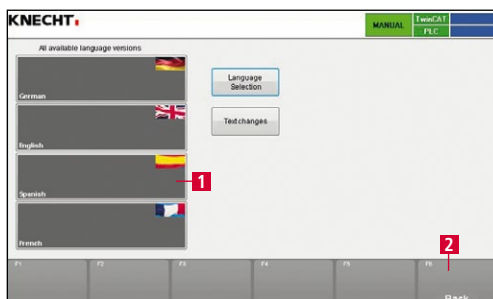

Figure 8-26 Select language

The desired language is selected and automatically activated by pressing the corresponding touch panel button (8-26/1).

Then press "F6 Back" (8-26/2) on the touch panel to return to the start screen.

The main screen appears on pressing "F4 Production" (8-24/2).

## 8. Control system

---

### 8.11 Setting up an internet connection

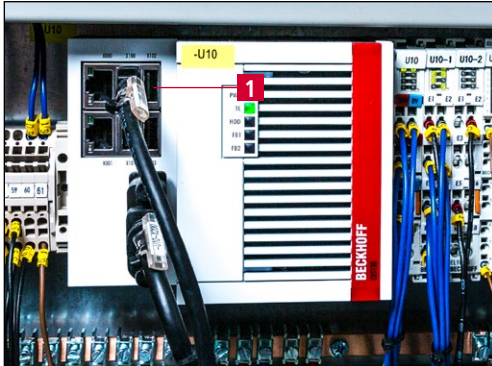

Figure 8-27 Network connection

The machine is equipped with an Ethernet port. A secure connection between the machine and KNECHT Maschinenbau GmbH can be established via the integrated VPN router. The connection can be activated or deactivated by the operator using the key switch on the control cabinet (8-27/1).

This connection gives the KNECHT service technician access to the control and allows him to diagnose the machine, change the software settings and upload or edit new grinding programs. There must be an active Internet connection to initiate the connection.

#### NOTICE

**When commissioning, the VPN router is configured according to the specified IT infrastructure so that the machine communicates exclusively with KNECHT Maschinenbau GmbH via the VPN server. Any communication within the customer network is excluded. The customer network is therefore optimally protected.**

**In order to establish the Internet connection, plug the supplied Ethernet cable into the on-site network socket (RJ45) and the network port on the control cabinet of the grinding machine.**

## 9. Care and maintenance

---



For all work on the grinding machine, the locally applicable safety and accident prevention regulations as well as instructions in the “Safety” and “Important Notes” section of the operating instructions must be observed.

### 9.1 Coolant

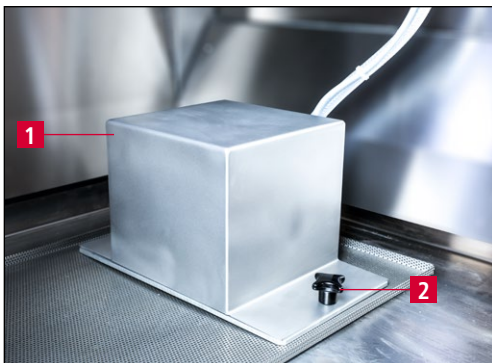

Figure 9-1 Water tray

The cooling water has to be replaced every week and the water tray must be cleaned.

The water trough must always be filled with water up to 3 cm below the rim. The water trough can be pulled out in front for filling and cleaning.

The pump (9-1/1) including the guard can be removed by loosening and removing the star handles (9-1/2).

### 9.2 Lubricate cross table

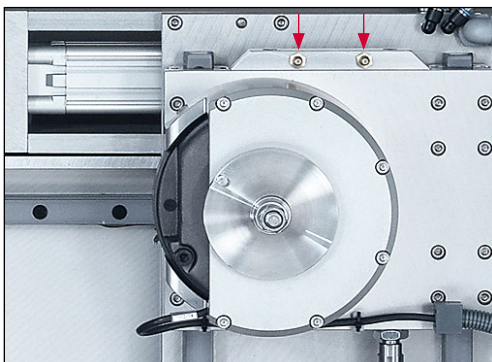

Figure 9-2 Lubricate cross table

Place grease gun on the lubrication points and lubricate the cross table.

We recommend “OEST Multi-Purpose Grease L2” or a similar commonly available product.

Press one round of grease into the lubrication point using the grease gun once a month.

## 9. Care and maintenance

---

### 9.3 Clean grinding machine

After grinding and/or dressing work, the grinding machine must be cleaned with a moist rag or a wet vacuum cleaner. Rub acid-free oil into the grinding machine. Clean the window with window cleaning agent.

#### ATTENTION

**Do not spray-wash the grinding machine with water. This can damage the machine.**

### 9.4 Other lubrication points

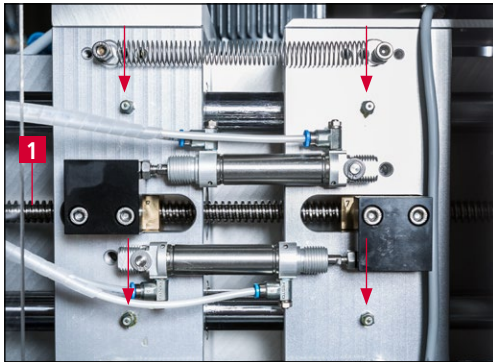

**Figure 9-3** Adjustment axis

Press one round of grease into the lubrication points at the marked places with grease gun once a month. Grease the spindle (9-3/1) once every month.

# 10. Malfunctions

---

## 10.1 Faults

Malfunction	Fault	Remedy
Knife is not being sharpened	The knife edge is not reached during the grinding operation, i.e. the grinding angle is too flat	Set a steeper grinding angle
	Burr formation on the knife edge	Use a less aggressive rear grinding wheel
	Number of cycles is set too low	Increase the number of cycles
	Grinding wheel is worn	Mount connection flange or new grinding wheel
The grinding machine does not run after pressing the "Start" button	Protection hood is open	Close the protection hood
	"Emergency Stop" button is activated	Release the "Emergency Stop" button and press the "Control ON" button
	Control unit is not switched on	Press the "Control ON" button
Control unit cannot be switched on	Motor protection switch has tripped	Switch on the motor protection switch

If a fault is not included in the faults table or if the fault is not eliminated, please contact our service staff (Chapter 12.2).

# 11. Disassembly and disposal

---

## 11.1 Disassembly

The operating materials must be disposed of correctly.

Secure moving parts against slipping.

The disassembly must be carried out by a qualified specialist company.

## 11.2 Disposal

At the end of service life, the machine must be disposed of by a qualified specialist company. In exceptional cases and by agreement with KNECHT Maschinenbau GmbH, the machine can be returned.

Operating materials (e.g. grinding wheels, coolants etc.) must also be disposed of correctly.



# 12. Service, spare parts and accessories

---

## 12.1 Postal address

KNECHT Maschinenbau GmbH  
Witschwender Straße 26  
88368 Bergatreute  
Germany

Phone +49-7527-928-0  
Fax +49-7527-928-32

mail@knecht.eu  
www.knecht.eu

## 12.2 Service

### **Service management:**

See postal address

service@knecht.eu

## 12.3 Wear and spare parts

If you need spare parts, please use the spare parts list provided with the machine. Please place your order as shown below.

### **Please always include the following information: (Example)**

Machine type	(A 950 II)
Serial no.	(1211069950-2)
Designation of module	(Slide X module)
Designation of component	(Cam disc bearing shaft Z axis)
Item no.	(12)
Drawing no.	(2000130-12428)
Quantity	(1)

Please feel free to contact us if you have any questions.

# 12. Service, spare parts and accessories

---

## 12.4 Accessories

### 12.4.1 Abrasives used

Designation	Dimensions	Standard	Article number
Boron nitride grinding wheel 15/10 K300NA-B46-C60	d.100x60x40	EN 171741	412F-73-1510-46

#### **ATTENTION**

**Only original abrasives, wear and spare parts from KNECHT Maschinenbau GmbH are permitted to be used.**

**KNECHT Maschinenbau GmbH assumes no responsibility for the use of non-original parts.**

If you require abrasives or other accessories, please contact our sales staff and distributors, or KNECHT Maschinenbau GmbH directly.

Thank you for choosing KNECHT!

# 13. Appendix

---

## 13.1 EU Declaration of Conformity

in accordance with EU Directive 2006/42/EU

- Machinery 2006/42/EU
- Electromagnetic Compatibility 2014/30/EU

We hereby declare that the machine designated as follows, due to its construction and design, as well as the version we placed on the market, complies with the relevant fundamental safety and health requirements of the applicable EU Directive.

In case of a modification of the machine not agreed with us, this declaration loses its validity.

<b>Designation of the machine:</b>	Grinding Machine for Sickle-shaped and Circular Knives
<b>Type designation:</b>	A 950 II
<b>Machine number:</b>	from no. 1211069950-2
<b>Applicable harmonized standards, in particular:</b>	DIN EN ISO 12100 DIN EN ISO 13850 DIN EN ISO 13857 DIN EN 13218 DIN EN 60204-1 DIN EN 349
<b>Responsible for documentation:</b>	Peter Heine (Dipl. Ing. Mechanical Engineering BA) Phone +49-7527-928-40 p.heine@knecht.eu
<b>Manufacturer:</b>	KNECHT Maschinenbau GmbH Witschwender Straße 26 88368 Bergatreute Germany

A complete technical documentation is available. The operating instructions document for the machine is available in its original version and in the native language of the user.

The validity of the declaration expires in the event of changes to the legal requirements.

Bergatreute, February 26, 2024

KNECHT Maschinenbau GmbH

  
Markus Knecht  
CEO

**KNECHT Maschinenbau GmbH**

Witschwender Straße 26 · 88368 Bergatreute · Germany · T +49-7527-928-0 · F +49-7527-928-32  
mail@knecht.eu · www.knecht.eu