

Operating Instructions

W 200 II

Surface Grinding Machine



Operating Instructions

W 200 II Surface Grinding Machine

Manufacturer

KNECHT Maschinenbau GmbH
Witschwender Straße 26
88368 Bergatreute
Germany

Phone +49-7527-928-0
Fax +49-7527-928-32

mail@knecht.eu
www.knecht.eu

Documents for machine operator

Operating Instructions

Date of issue of the operating instructions

May 31, 2024

Copyright

These operating instructions as well as the operating documents remain the copyright property of KNECHT Maschinenbau GmbH. They are supplied only to customers and operators of our products and belong to the machine.

Without our express permission, these documents may neither be duplicated nor made accessible to third parties, in particular competitor companies.

Table of Contents

1.	Important notes	7
1.1	Preface to the operating instructions	7
1.2	Warnings and symbols in the operating instructions	7
1.3	Warning and mandatory signs and their meaning	8
1.3.1	Warning and mandatory signs on/in the grinding machine	8
1.3.2	General warning- and mandatory signs	8
1.4	Rating plate and machine serial number	9
1.5	Figure and position numbers in the operating instructions	9
2.	Safety	10
2.1	Basic safety instructions	10
2.1.1	Observe notes in the operating instructions	10
2.1.2	Obligation on the part of the operator	10
2.1.3	Obligation on the part of the personnel	10
2.1.4	Hazards involved in handling the grinding machine	10
2.1.5	Malfunctions	11
2.2	Intended use	11
2.3	Warranty and liability	11
2.4	Safety regulations	12
2.4.1	Organizational measures	12
2.4.2	Protective equipment	12
2.4.3	Informal safety measures	12
2.4.4	Selection and qualification of personnel	12
2.4.5	Machine control system	13
2.4.6	Safety measures in normal operation	13
2.4.7	Hazards due to electrical power sources	13
2.4.8	Particular hazard areas	13
2.4.9	Servicing (maintenance, repair) and fault rectification	13
2.4.10	Structural alterations to the grinding machine	14
2.4.11	Cleaning the grinding machine	14
2.4.12	Lubricants/oils and greases	14
2.4.13	Relocation of the grinding machine	14
3.	Description	15
3.1	Intended use	15
3.2	Technical specifications	15
3.3	Functional description	16
3.4	Description of the assemblies	17
3.4.1	Rotary table	18
3.4.2	Centering pieces	18
3.4.3	Feed lever for grinding unit	18
3.4.4	Switching the grinding machine on/off	19
3.4.5	Control panel	20
3.4.6	Coolant unit	21
3.4.7	Suction unit	21

Table of Contents

4.	Transport	22
4.1	Transport aids	22
4.2	Transport damage	22
4.3	Transport to another installation site	22
5.	Installation	23
5.1	Selection of qualified personnel	23
5.2	Installation site	23
5.3	Supply connections	23
5.4	Settings	23
5.5	Initial start-up of the grinding machine	24
6.	Commissioning	25
7.	Operation	28
7.1	Switch on the grinding machine	28
7.2	Surface grinding mincer plates	28
7.2.1	Moving the grinding unit to the change position	28
7.2.2	Clamping the mincer plate	29
7.2.3	Setting the working position	30
7.2.4	Moving the grinding unit to the grinding position	32
7.2.5	Surface grinding the mincer plate	32
7.3	Surface grinding cross knives	35
7.3.1	Moving the grinding unit to the change position	35
7.3.2	Clamping the cross knife	36
7.3.3	Setting the working position	37
7.3.4	Moving the grinding unit to the grinding position	38
7.3.5	Surface grinding the cross knife	39
7.4	Setting the coolant supply	42
7.5	Dressing the CBN grinding wheel	43
7.5.1	Positioning the dressing device on the rotary table	43
7.5.2	Setting the working position	44
7.5.3	Moving the grinding unit into position	45
7.5.4	Dressing the grinding wheel	46
7.6	Changing the grinding wheel	47
8.	Care and maintenance	49
8.1	Cleaning	49
8.1.1	Cleaning agent and lubricant table	49

Table of Contents

8.1.2	Cleaning the rotary table	50
8.1.3	Checking the suction unit	50
8.1.4	Cleaning the suction hose	51
8.2	Maintenance plan (one-shift operation)	52
8.3	Lubrication	53
8.4	Coolant additive	54
8.4.1	Measuring the cooling lubricant concentration	54
8.4.2	Maintenance schedule for cooling lubricant	55
9.	Disassembly and disposal	56
9.1	Disassembly	56
9.2	Disposal	56
10.	Service, spare parts and accessories	57
10.1	Postal address	57
10.2	Service	57
10.3	Wear and spare parts	57
10.4	Accessories	58
10.4.1	Abrasives used etc.	58
11.	Appendix	59
11.1	EU Declaration of Conformity	59

1. Important notes

1.1 Preface to the operating instructions

These operating instructions are intended to make it easy to learn how to use the Surface Grinding Machine, hereafter referred to as grinding machine and to properly utilize its features.

These operating instructions contain important notes on how to operate the grinding machine safely, properly and efficiently. Observing these instructions helps to avoid hazards, reduce repair costs and downtimes, and to increase the reliability and service life of the grinding machine.

The operating instructions must always be stored in the location that the grinding machine is used.

The operating instructions must be read and applied by every person tasked with working with the grinding machine, e.g.:

- transport, installation, commissioning
- operation, including error rectification during operation, as well as
- servicing (maintenance, repair).

Recognized technical standards for safe and professional work must be observed in addition to these operating instructions and the binding accident prevention regulations applicable in the country of use and at the place of use.

1.2 Warnings and symbols in the operating instructions

The operating instructions use the following symbols/designations that must be followed:



The hazard triangle with the signal word "CAUTION" serves as a work safety notice for all work for which there is a risk of personal injury or death.

In these cases, work should be done with special attention and care.



"ATTENTION" is written in places where special attention must be paid to prevent damage or destruction of the grinding machine or its surroundings.



"NOTICE" refers to user tips and especially useful informations.

1. Important notes

1.3 Warning and mandatory signs and their meaning

1.3.1 Warning and mandatory signs on/in the grinding machine

The following warnings and mandatory signs have been affixed on/in the grinding machine:



CAUTION! CAUTION! DANGEROUS ELECTRICAL VOLTAGE! (warning sign on the control cabinet)

The grinding machine carries life-threatening voltage when it is connected to the power supply.

Voltage-carrying device parts may only be opened by authorized personnel.

The grinding machine must be separated from the mains supply before carrying out servicing, maintenance and repair work on it.

1.3.2 General warning- and mandatory signs

The following general mandatory signs must be observed:



CAUTION! RISK OF INJURY FROM KNIFE!

Working with the grinding machine involves grinding knives that could cause serious cut injuries due to their sharpness.

Caution when transporting knives. Use the protective equipment provided by the knife manufacturer. Protective gloves and safety shoes must be worn.

Protective gloves must also be worn when changing the coolant (see Chapter 8.1).

1. Important notes

1.4 Rating plate and machine serial number



Figure 1-1 Rating plate

The rating plate (1-1) is located on the right side of the machine.

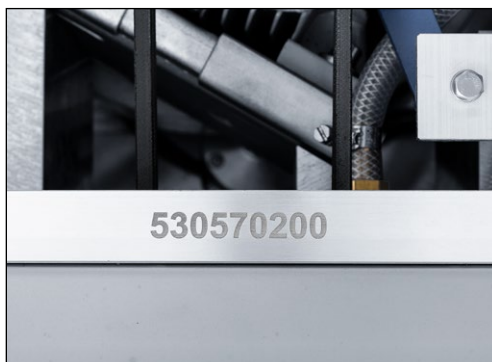

Figure 1-2 Machine number

The machine serial number (1-2) is located on the rating plate (1-1) and at the top of the machine compartment, visible through the KNECHT logo.

1.5 Figure and position numbers in the operating instructions

If the text makes a reference to a machine component depicted in a figure, the figure and position number will be given in brackets.

Example: (7-13/1) means picture number 7-13, position 1.



Figure 7-13 "Grinding unit" fine adjustment

For grinding, feed the grinding unit with the fine adjustment (7-13/1) using the hand wheel of the feed lever until a clear spark is visible.

2. Safety

2.1 Basic safety instructions

2.1.1 Observe notes in the operating instructions

The basic prerequisite for the safe handling and uninterrupted operation of this grinding machine is knowledge of the basic safety instructions and regulations.

- These operating instructions contain important notes on how to operate the grinding machine safely.
- All persons carrying out work on the grinding machine must follow these operating instructions, in particular the safety notices.
- In addition, the rules and regulations regarding accident prevention at the place of use are to be observed.

2.1.2 Obligation on the part of the operator

The operator is obliged to allow only those persons to work on the grinding machine, who

- are familiar with the occupational safety and accident prevention regulations and have received instruction in handling the grinding machine,
- have read and understood the operating instructions, in particular the section entitled "Safety" and the warning notes, and have provided signed confirmation of this.

The safety-awareness of the personnel at work will be monitored at regular intervals.

2.1.3 Obligation on the part of the personnel

All personnel working on the grinding machine shall be obliged, before starting work, to

- observe basic occupational safety and accident prevention regulations,
- read the operating instructions, particularly the section entitled "Safety" and the warning notes, and provide signed confirmation that they have understood them.

2.1.4 Hazards involved in handling the grinding machine

The grinding machine has been built to the latest technological standards and the recognized rules of technical safety. In spite of this, its use poses inherent risks which could result in bodily harm or even death of the user or third persons, or damage to the grinding machine or other property.

The grinding machine may be used only:

- for its intended purpose
- in a safe and secure condition.

Malfunctions that may impair safety are to be eliminated immediately.

2. Safety

2.1.5 Malfunctions

If safety-relevant malfunctions occur with the grinding machine, or if the processing behavior indicates that such malfunctions may have occurred, the grinding machine must be stopped immediately and until such time as the malfunction has been found and eliminated.

Allow only authorized trained personnel to eliminate the malfunctions.

2.2 Intended use

The grinding machine is only suitable for surface grinding cutting sets for mincers, inline grinders and emulsifiers, hereinafter also called workpiece.

All knives must be centered on the rotary table and fixed with a driver.

Any other use or use beyond this is not considered as intended. KNECHT Maschinenbau GmbH is not liable for any damage resulting from this. The risk is borne solely by the user.

Intended use also includes observing all instructions in the operating manual.

ATTENTION

Improper use of the grinding machine exists, for example, if:

- **fixtures are not properly attached.**
- **workpieces other than those described in Chapter 2.2 are ground.**

2.3 Warranty and liability

Warranty and liability claims in case of personal injury or property damage are excluded if such damage is attributable to one or more of the following causes:

- improper use of the grinding machine,
- improper transport, commissioning, operation, and maintenance of the grinding machine,
- operating the grinding machine with defective safety devices, or using improperly attached or malfunctioning safety and protective equipment,
- failure to observe the instructions with regard to transportation, commissioning, operation, maintenance and repair of the grinding machine,
- unauthorized structural alterations to the grinding machine,
- unauthorized modification, e.g. of the drive conditions (output and speed),
- failure to monitor machine parts that are subject to wear, and

2. Safety

- use of unapproved replacement and wear parts.

Use only original replacement and wear parts. If externally purchased parts are used, it is not guaranteed that they have been designed and manufactured to meet the requirements in terms of stress and safety.

2.4 Safety regulations

2.4.1 Organizational measures

Inspect all available safety devices regularly.

Observe prescribed intervals for recurring maintenance work or as specified in the operating instructions!

2.4.2 Protective equipment

Before every commissioning of the grinding machine, ensure that all protective equipment is properly mounted and in functional condition.

Protective equipment may be removed only after the grinding machine has stopped and has been secured against accidental restart.

When attaching spare parts, the protective equipment must be attached by the operator as stipulated.

2.4.3 Informal safety measures

The operating instructions must be permanently available at the place of use of the grinding machine. In addition to the operating instructions, the generally applicable as well as locally relevant accident prevention regulations must also be made available and observed.

All safety alert symbols and hazard warnings on the grinding machine must be complete and clearly legible.

2.4.4 Selection and qualification of personnel

Only trained and instructed personnel may work on the grinding machine. Observe the legally permitted minimum age!

The responsibilities of personnel with respect to commissioning, operation, maintenance, and repair must be clearly specified.

Personnel still undergoing training or instruction may only work on the grinding machine under the permanent supervision of an experienced person!

2. Safety

2.4.5 Machine control system

Only trained and instructed personnel are permitted to switch on and operate the machine.

2.4.6 Safety measures in normal operation

Do not operate the machine in any unsafe manner. Only operate the grinding machine if all the safety devices are installed and fully functional.

At least once per shift (or per day), check the grinding machine for externally visible damage and proper functioning of the safety devices.

Immediately report any changes present (including those of the operating behavior) to the responsible office or person. If necessary, immediately shut down the grinding machine and secure it against restart.

Before you switch on the grinding machine, ensure that no one can be injured by the start-up of the machine.

In the event of a malfunction, immediately stop the grinding machine and secure it against restart. Rectify malfunctions immediately.

2.4.7 Hazards due to electrical power sources

Work on electrical systems or operating materials may only be performed by a qualified electrician, in accordance with electrical regulations.

Defects, such as damaged cables, cable connections, etc. must be immediately rectified by an authorized specialist.



The yellow power supply cable is electrically live even when the main switch is turned off.

2.4.8 Particular hazard areas

In the area of the grinding wheel there is a hazard of pinching and of drawing in e.g. clothing, fingers and hair. Suitable personal protective equipment must be worn.

2.4.9 Servicing (maintenance, repair) and fault rectification

Maintenance work is to be carried out on schedule by trained personnel. Inform operating personnel before beginning repair work. Designate a supervisor responsible for this.

2. Safety

For all service work, the grinding machine is to be disconnected from the current supply and secured against accidental restart. Remove power plug. Secure repair area as necessary.

After completing maintenance work and rectifying any faults, install all safety devices and verify that they are fully functional.

2.4.10 Structural alterations to the grinding machine

Do not make any changes, additions or conversions to the grinding machine without the approval of the manufacturer. This also applies to the installation and setup of safety devices.

Any conversion work requires the written permission from KNECHT Maschinenbau GmbH.

Immediately replace machine parts that are not in perfect condition.

Use only original replacement and wear parts. If externally purchased parts are used, it is not guaranteed that they have been designed and manufactured to meet the requirements in terms of stress and safety.

2.4.11 Cleaning the grinding machine

Properly handle any cleaning agents and materials used and dispose of them in an environmentally-friendly manner.

Dispose of the wear parts and replacement parts in a safe and environmentally-friendly manner.

2.4.12 Lubricants / oils and greases

When using oils and greases, follow the safety regulations applicable to the product. Comply with the special regulations for the food areas.

2.4.13 Relocation of the grinding machine

Disconnect the grinding machine from any external power supply, even in the event of a minor change of location. Before restarting the grinding machine, connect it properly to the power supply.

For loading work, use only lifting equipment and load-bearing devices with sufficient lifting capacity. Appoint a qualified instructor for the lifting operation.

No persons other than those designated for this work may be present in the loading and installation area.

Only lift the grinding machine properly with lifting gear as specified in the operating instructions. Only use a suitable transport vehicle with sufficient load-bearing capacity. Secure the load reliably. Use suitable attachment points.

When restarting the machine, proceed only in accordance with the operating instructions.

3. Description

3.1 Intended use

The W 200 II Surface Grinding Machine sharpens cutting sets for mincers, inline grinders and emulsifiers up to a diameter of 200 mm.

3.2 Technical specifications

Height (maximum, when feed lever is up)	_____	approx. 1950 mm
Width	_____	approx. 1265 mm
Depth (maximum, when feed lever is in front)	_____	approx. 980 mm
Space requirement (WxD)	_____	2000 x 1500 mm
Weight	_____	approx. 400 kg
Power supply*	_____	3x 400 V
Mains frequency*	_____	50 Hz
Power output*	_____	3.5 kW
Power consumption*	_____	6 kW
Current consumption*	_____	7 A
Back-up fuse*	_____	16 A
Operating noise level (measured A-weighted emission sound pressure level at the workplace LpA)**	_____	approx. 72 dB (A)
Rotary table diameter	_____	200 mm
Rotary table speed	_____	53 1/min
Grinding wheel diameter	_____	100 mm
Grinding wheel speed	_____	4500 1/min
Cutting speed with grinding wheel d.100***	_____	24 m/s

*) This information may change depending on the electrical power supply.

**) Two-digit sound emission value according to EN ISO 4871 (measurement uncertainty KpA. 3 dB (A)). Emission sound pressure level according to EN ISO 11201. A mincer plate (d. 200 mm) from the company Turbocut was ground.

***) Caution! The cutting speed of 24 m/s is achieved at 50 Hz. An electrical supply with a higher frequency results in higher cutting speeds. Only use abrasives permitted for this purpose.

3. Description

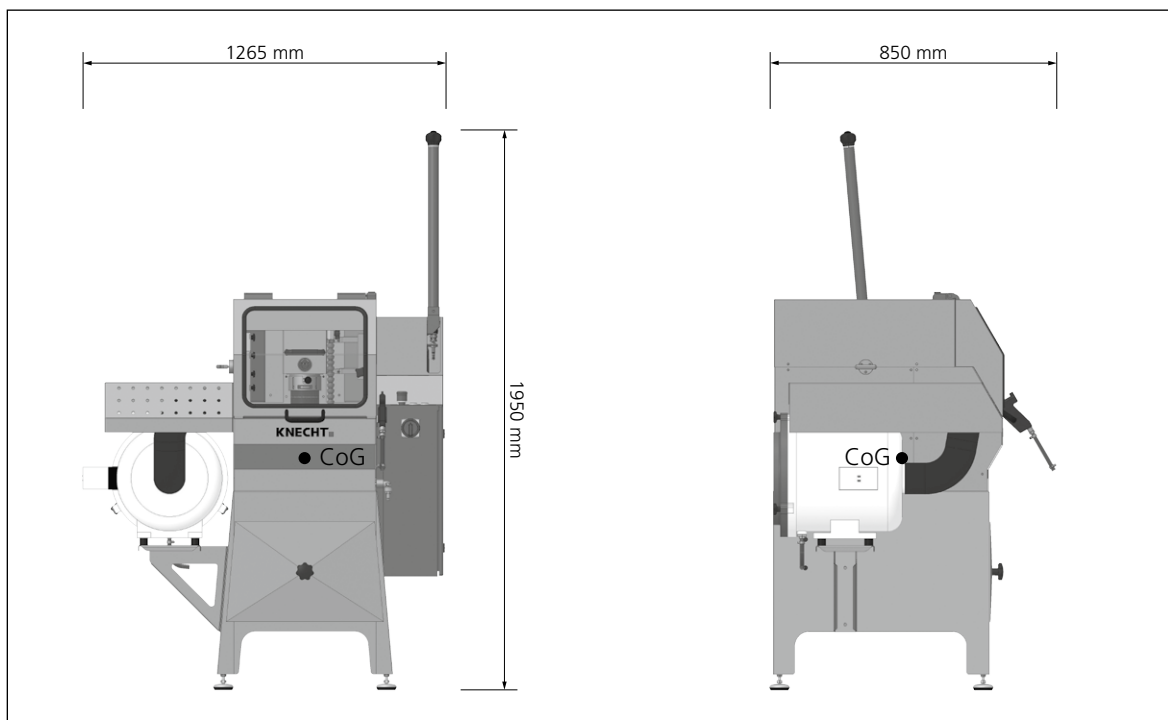

Figure 3-1 Dimensions in mm and centers of gravity (CoG) of the machine

3.3 Functional description

The W200II Surface Grinding Machine is used to grind cutting sets for mincers, inline grinders and emulsifiers up to a diameter of 200 mm.

Mincer plates are fixed on the rotary table of the W200II Surface Grinding Machine using centering pieces and a driver.

Cross knives are fixed for surface grinding on a mincer plate with the enclosed centering piece for cross knives.

Special fixtures are also available for special applications.

The machine is supplied as standard with a CBN grinding wheel and an air cleaning unit (hereinafter called suction unit).

3. Description

3.4 Description of the assemblies

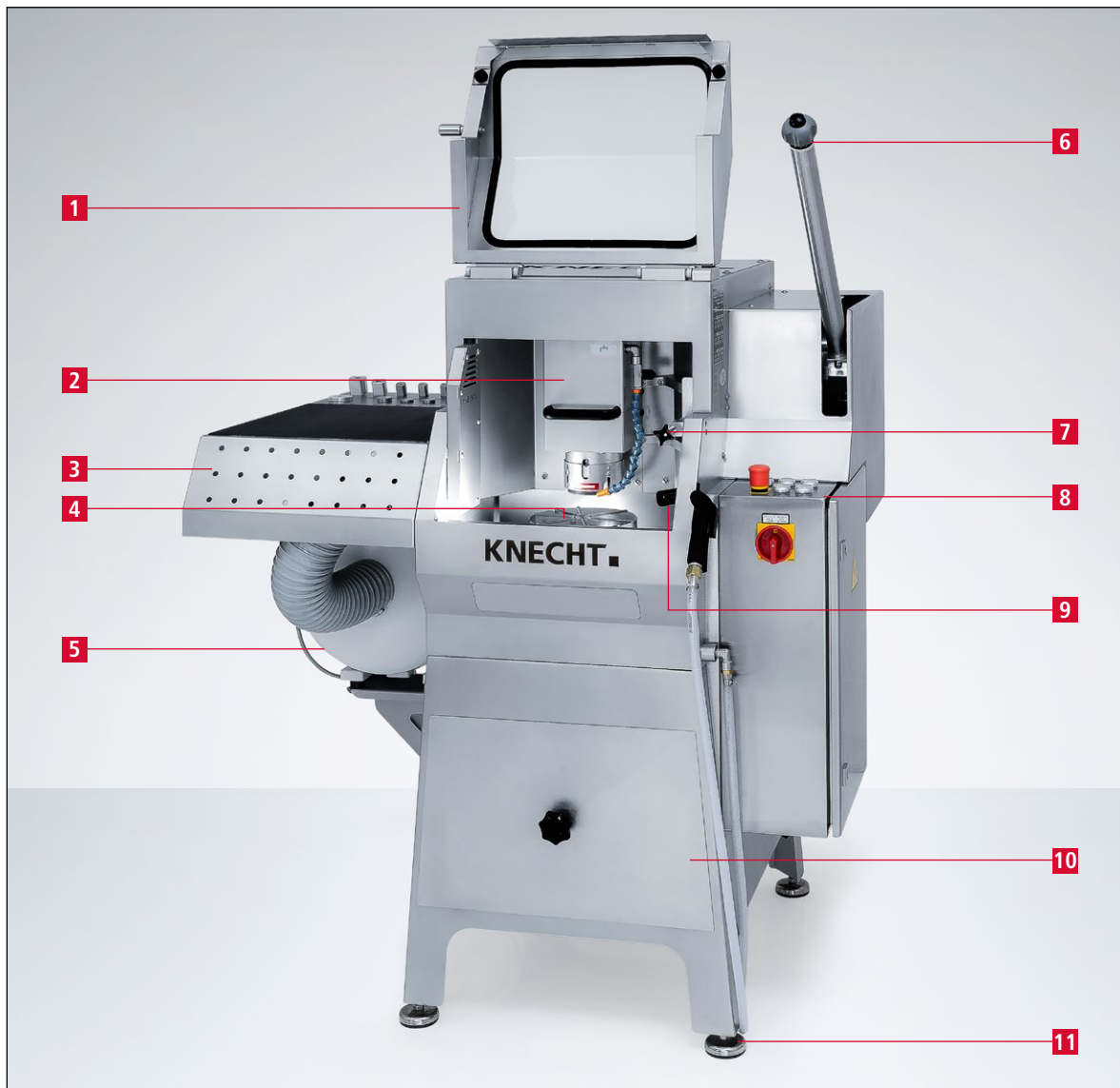

Figure 3-2 General view of grinding machine

- 1 Safety flap
- 2 Grinding unit
- 3 Stainless steel shelf
- 4 Rotary table
- 5 Suction Unit
- 6 "Grinding unit" feed lever
- 7 "Grinding unit" stop
- 8 Control panel
- 9 LED working light
- 10 Coolant unit
- 11 Adjustable machine feet

3. Description

3.4.1 Rotary table



Figure 3-3 Rotary table

For processing, the workpieces are placed and centered on the rotary table (3-3/1).

The rotary table is driven by a spur gear.

3.4.2 Centering pieces



Figure 3-4 Centering piece and driver

Centering pieces (3-4/1) and the driver (3-4/2) are used to hold and correctly align the workpieces on the rotary table.

The centering piece matching the cutting tool is inserted into the hole in the middle of the rotary table.

The workpieces are fixed to the rotary table with the driver.

3.4.3 Feed lever for grinding unit

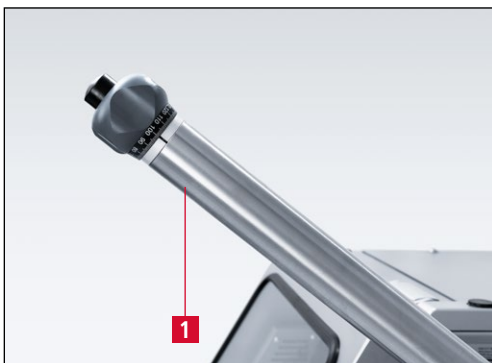

Figure 3-5 Feed lever

The grinding unit is fed using the feed lever (3-5/1).

3. Description

3.4.4 Switching the grinding machine on/off



Figure 3-6 Main switch

The main switch is located on the rear of the control panel.

Turning the main switch to position "1 ON" activates the grinding machine ready for operation.

Turning the main switch to position "0 OFF" disconnects the grinding machine from the power supply.

3. Description

3.4.5 Control panel



Figure 3-7 Control panel

- 1 "Grinding wheel On/Off" button: Switch on/off the grinding wheel
- 2 "Rotary table On/Off" button: Switch on/off rotary table rotation
- 3 "Coolant On/Off" button: Switch on/off the coolant pump
- 4 "Emergency stop" button
- 5 "Control ON" button: Activate PLC control
- 6 "Drives On/Off" button: Switch on/off drives for grinding wheel, rotary table, coolant pump and suction unit

3. Description

3.4.6 Coolant unit

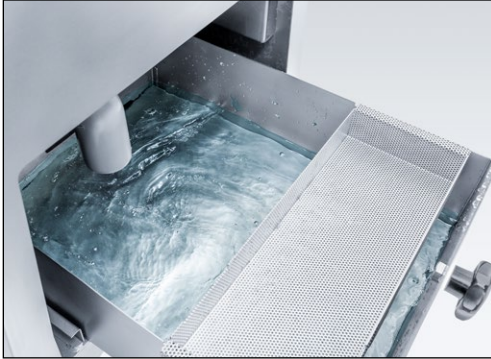

Figure 3-8 Coolant unit

The coolant unit is located in the base of the machine.

3.4.7 Suction unit

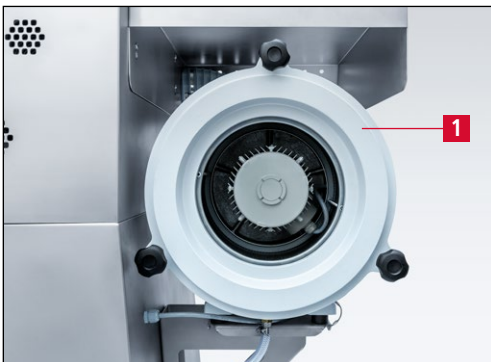

Figure 3-9 Suction unit

The suction unit (3-9/1) is located on the left side of the surface grinding machine.

4. Transport



When transporting, observe the local applicable safety and accident prevention regulations.

Only transport the grinding machine with the machine feet facing downwards.

4.1 Transport aids

For transporting and for setting up of the grinding machine, only use adequately dimensioned transport aids e.g. truck, forklift or hydraulic lifting truck.

When using a forklift or a lifting truck, move the fork under the grinding machine.

Note the machine's center of gravity when transporting. The center of gravity (CoG) is shown in Figure 3-1.

4.2 Transport damage

If damage is detected during acceptance of the delivery, immediately inform KNECHT Maschinenbau GmbH and the forwarding agent. If necessary, an independent expert must be called in immediately.

Remove packaging and fastening straps. Remove the shipping straps on the grinding machine. Dispose of packaging in an environment-friendly manner.

4.3 Transport to another installation site

For transport to another installation site, ensure that the space requirements are fulfilled (see Chapter 3.2).

A permissible electrical connection must be provided at the new installation site. The grinding machine must stand firmly and securely.



Work on the electrical unit is only to be carried out by an authorized specialist. Observe the locally applicable safety and accident prevention regulations.

5. Installation

5.1 Selection of qualified personnel



We recommend having the installation work on the grinding machine carried out by the trained KNECHT personnel.

We are not liable for any damage resulting from improper installation.

5.2 Installation site

When determining the installation site, bear in mind the space required for installation as well as maintenance and repair work on the grinding machine (see Chapter 3.2).

5.3 Supply connections

The grinding machine is provided ready to connect with the corresponding connection cable.

Have the power supply installed on site by a qualified electrician.



Check that the power supply is connected correctly.

If the connection to the voltage supply is incorrect, the grinding wheel can rotate in reverse of the prescribed direction. An incorrect direction of rotation can result in serious injuries.

Observe the prescribed rotating direction, see Chapter 6.

5.4 Settings

KNECHT Maschinenbau GmbH will configure the various components as well as the electrical system before delivery.

ATTENTION

Unauthorized alterations to the preset values are not permitted and can damage the grinding machine.

5. Installation

5.5 Initial start-up of the grinding machine

Place the grinding machine at the installation site on a level base.

Compensate uneven floors by turning the machine feet (3-2/11) with an AF 19 mm open-end wrench.

Have the power supply installed on site by a qualified electrician.

Completely install and inspect the protective equipment before commissioning.



Have all protective equipment checked for proper functioning by authorized trained personnel before commissioning the machine.

6. Commissioning



CAUTION

All work may only be carried out by authorized specialist personnel.

Observe the locally applicable safety and accident prevention regulations.

Check that the power supply is connected correctly.

If the connection to the voltage supply is incorrect, the grinding wheel can rotate in reverse of the prescribed direction. An incorrect direction of rotation can result in serious injuries.

Observe the prescribed rotating direction!

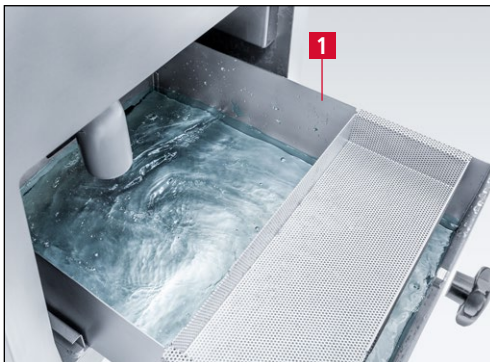

Figure 6-1 Filling the coolant unit

Fill the coolant unit (6-1/1) with approx. 35 liters water and approx. 1.8 liters Colometa SBF-PN coolant additive (mixing ratio 1:20) (see Chapter 8.4).



Figure 6-2 Adjusting the drain

The drain (6-2/1) must be positioned to ensure that the dirty water can flow into the strainer basket.

The strainer basket is held in place by recesses.

Connect the power plug to the socket provided on site (3x 400 V, 16 A) and set the main switch (3-6) to the position "1 ON".

6. Commissioning



Figure 6-3 Control panel

Press the “Control On” button (6-3/1) on the control panel. The PLC control is activated when the button lights up.

Close the safety flap (3-2/1).

Press the “Rotary table On/Off” button (6-3/2).

The rotary table rotates.

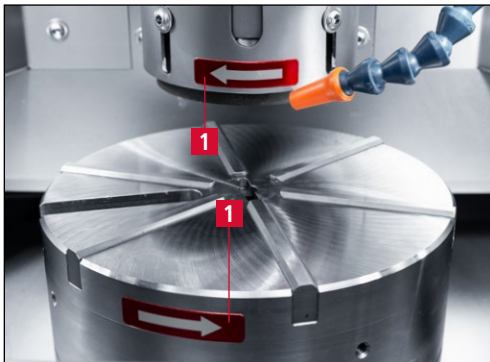

Figure 6-4 Check rotating direction

Check the rotating direction.

The direction arrows (6-4/1) indicate the rotating directions of the rotary table and grinding wheel.

If the rotating direction of the grinding wheel is incorrect, have the phase reversed by a qualified electrician.

After ensuring the prescribed rotating direction, press the “Rotary table On/Off” button (6-3/2) again to switch off the rotary table.

ATTENTION

When commissioning, first check the direction of rotation of the rotary table. The rotary table must rotate counterclockwise.

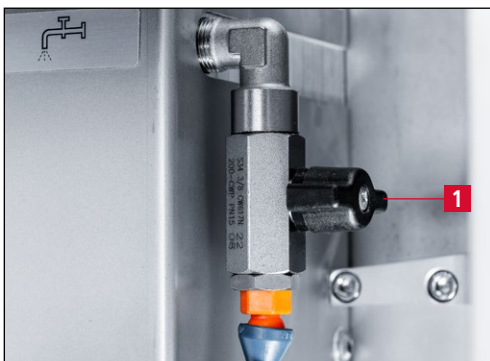

Figure 6-5 Coolant tap

Switch on the coolant pump by pressing the “Coolant On/Off” button (6-3/3).

The coolant supply is regulated using the coolant tap (6-5/1) (see Chapter 7.4).

6. Commissioning

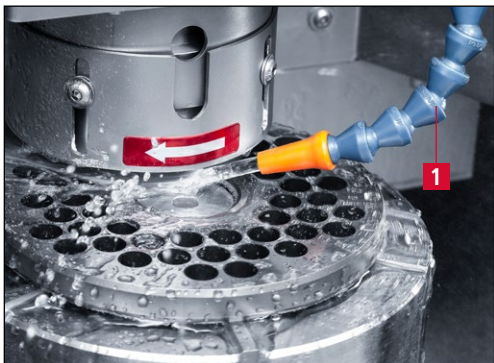

Figure 6-6 Coolant hose

ATTENTION

The coolant hose (6-6/1) is flexible and must be adjusted so that the coolant flows directly onto the grinding point between the workpiece and grinding wheel.

Switch off the coolant pump by pressing the "Coolant On/Off" button (6-3/3) again.

Check the coolant level regularly before grinding.

Always grind with coolant, otherwise there is a risk of overheating the workpieces and a fire hazard in the suction unit!

Switch off the grinding machine.

To do this, turn the main switch (3-6) to the position "0 OFF".

7. Operation



All work may only be carried out by authorized specialist personnel.

The applicable local safety and accident prevention regulations must be observed.

7.1 Switch on the grinding machine

Set the main switch (see Figure 3-6) to the "1 ON" position. Press the "Control On" button (3-7/1). The PLC control is activated when the button lights up.

7.2 Surface grinding mincer plates

7.2.1 Moving the grinding unit to the change position



Figure 7-1 Releasing the locking handle

To place the mincer plate, move the grinding unit back.

To do this, pull out the locking handle (7-1/1) on the left side of the machine and open the interlock of the grinding unit by turning it to a horizontal position.



Figure 7-2 Moving the grinding unit backwards

Move the grinding unit backwards to the end position using the handle (7-2/1).

7. Operation



Figure 7-3 "Grinding unit" feed lever

Unlock the feed lever (7-3/1) electromechanically. To do this, press the button (7-3/2) on the hand wheel of the feed lever.

Press the feed lever (7-3/1) upwards to move the grinding unit to the change position.

Once the desired position has been reached, release the button (7-3/2). The feed lever (7-3/1) is locked again electromechanically.

Lock the grinding unit again with the locking handle (7-1/1) on the left-hand side of the machine.

7.2.2 Clamping the mincer plate

NOTE

The rotary table must be cleaned before clamping the mincer plate (see Chapter 8.1.2).

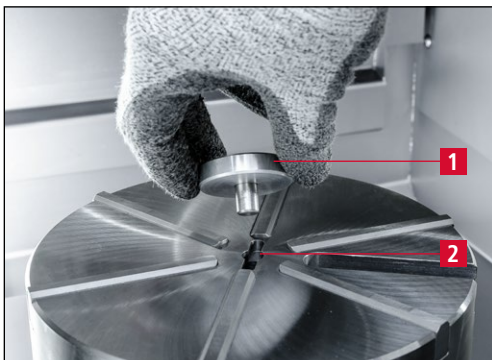

Figure 7-4 Centering piece

The workpieces are held and correctly aligned on the rotary table using centering pieces and the driver.

Insert the centering piece (7-4/1) that matches the mincer plate into the hole (7-4/2) in the middle of the rotary table.

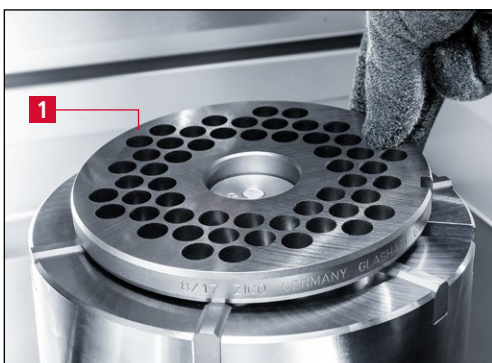

Figure 7-5 Placing the mincer plate on the rotary table

Place the mincer plate (7-5/1) over the centering piece on the rotary table.

7. Operation



Figure 7-6 Fixing the mincer plate

Move the driver (7-6/1) in the guide groove (7-6/2) and use a hexagon screwdriver AF 5 mm to secure the mincer plate against rotation.

7.2.3 Setting the working position



Figure 7-7 Grinding unit in working position

The working position of the grinding unit varies depending on the workpiece size. The correct working position is reached when the entire cutting surface of the workpiece is covered by the grinding wheel.

NOTE

The grinding wheel must not protrude beyond the center of the workpiece.



Figure 7-8 Opening the locking handle

The position of the grinding unit is adjusted as follows:

Pull out the locking handle (7-8/1) on the left side of the machine and open the interlock of the grinding unit by turning it to a horizontal position.

7. Operation



Figure 7-9 Moving the grinding unit into the working position

Pull the grinding unit forwards over the work-piece using the handle (7-9/1) until it reaches the approximate working position.

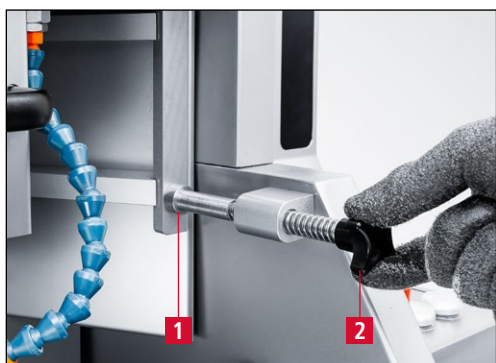

Figure 7-10 Determining the final working position of the grinding unit

The final working position of the grinding unit is set with the stop (7-10/1).

Turn the stop (7-10/1) using the star handle (7-10/2) until the desired working position is reached.



Figure 7-11 Closing the locking handle

Then lock the grinding unit with the locking handle (7-11/1) on the left side of the machine.

ATTENTION

The grinding unit must be engaged in the interlock!

7. Operation

7.2.4 Moving the grinding unit to the grinding position



Figure 7-12 "Grinding unit" feed lever

Lower the grinding unit to just above the mincer plate using the feed lever (7-12/1).

To do this, unlock the feed lever by pressing the button (7-12/2) on the hand wheel and pull it down.

Once the desired position has been reached, release button (7-12/2).

ATTENTION

The grinding wheel may only touch the workpiece when the drives are switched on.

7.2.5 Surface grinding the mincer plate



Figure 7-13 Control panel

Close the safety flap (3-2/1).

Start the rotary table, grinding wheel, coolant pump and suction unit by pressing the "Drives On/Off" button (7-13/1).

ATTENTION

Always grind with coolant, otherwise there is a risk of overheating the workpieces and a fire hazard in the suction unit!

NOTE

The machine is electrically secured and the units can only be operated when the safety flap is closed.

7. Operation



Figure 7-14 "Grinding unit" fine adjustment

For grinding, feed the grinding unit with the fine adjustment (7-14/1) using the hand wheel of the feed lever until a clear spark is visible.



Figure 7-15 Grinding mincer plates

Allow the machine to work without further infeed until the sparking subsides.

Feed repeatedly until the workpiece is evenly surface-ground.



Figure 7-16 Moving the grinding unit upwards

After the grinding process, move the grinding unit upwards with the feed lever (7-16/1) until the drives stop automatically.

To do this, unlock the feed lever by pressing the button (7-16/2) on the hand wheel and push it upwards.

Open the safety flap (3-2/1).

7. Operation



Figure 7-17 Rinsing the mincer plate and rotary table

Remove the mincer plate from the rotary table.

Rinse the mincer plate and rotary table (7-17).

Turn the mincer plate over and grind the back as described below.

Clamp the mincer plate (Chapter 7.2.2)

Set the working position (Chapter 7.2.3)

Move the grinding unit into the grinding position (Chapter 7.2.4)

Surface grind the mincer plate (Chapter 7.2.5)

Remove the mincer plate from the rotary table.

Rinse the mincer plate and rotary table (7-17).

Then oil with a lubricant approved for use in the food industry to prevent corrosion (see Chapter 8.1.1).

NOTE

The rotary table must be cleaned after each grinding process (see Chapter 8.1.2).

In order to prevent corrosion, oil the cutting tool after grinding with a lubricant approved for use in the food industry (see Chapter 8.1.1).

7. Operation

7.3 Surface grinding cross knives

7.3.1 Moving the grinding unit to the change position

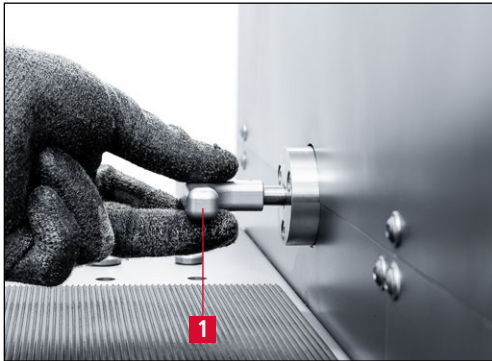

Figure 7-18 Releasing the locking handle

To place the cross knife, move the grinding unit back.

To do so, pull out the locking handle (7-18/1) on the left side of the machine and open the interlock of the grinding unit by turning it to a horizontal position.



Figure 7-19 Moving the grinding unit backwards

Move the grinding unit backwards to the end position using the handle (7-19/1).



Figure 7-20 "Grinding unit" feed lever

Unlock the feed lever (7-20/1) electromechanically. To do this, press the button (7-20/2) on the hand wheel of the feed lever.

Press the feed lever (7-20/1) upwards to move the grinding unit to the change position.

Once the desired position has been reached, release the button (7-20/2). The feed lever (7-20/1) is locked again electromechanically.

Lock the grinding unit again using the locking handle (7-18/1) on the left-hand side of the machine.

7. Operation

7.3.2 Clamping the cross knife

NOTE

The rotary table must be cleaned before clamping the cross knife (see Chapter 8.1.2).

Insert the centering piece (7-21/1) that matches the cross knife into the hole (7-21/2) in the middle of the rotary table.

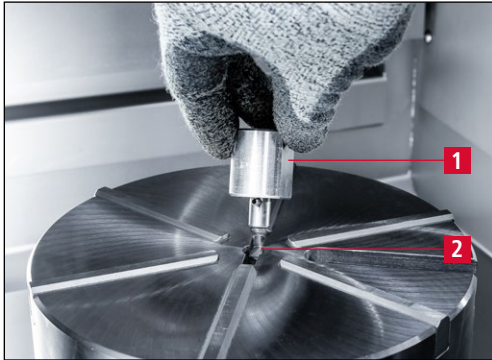

Figure 7-21 Centering piece

First place the matching, surface-ground mincer plate (7-22/1) over the centering piece (7-22/2) on the rotary table.



Figure 7-22 Placing the mincer plate on the rotary table

Then place the cross knife (7-23/1) on the mincer plate (7-23/2).

The collar of the cross knife (7-23/3) lies in the hole of the mincer plate.



Figure 7-23 Cross knife on rotary table

7. Operation

7.3.3 Setting the working position



Figure 7-24 Grinding unit in working position

The working position of the grinding unit varies depending on the workpiece size. The correct working position is reached when the entire cutting surface of the workpiece is covered by the grinding wheel.

NOTE

The grinding wheel must not protrude beyond the center of the workpiece.



Figure 7-25 Opening the locking handle

The position of the grinding unit is set as follows:

Pull out the locking handle (7-25/1) on the left side of the machine and open the interlock of the grinding unit by turning it to a horizontal position.



Figure 7-26 Moving the grinding unit into the working position

Pull the grinding unit forwards over the workpiece using the handle (7-26/1) until it reaches the approximate working position.

7. Operation

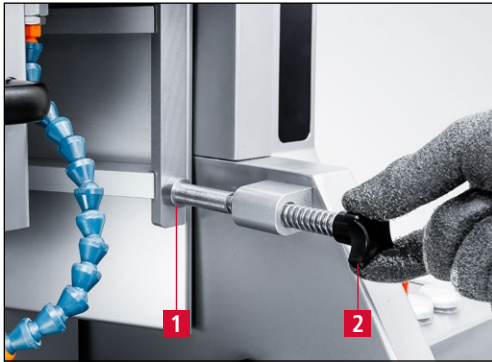

Figure 7-27 Determining the final working position of the grinding unit

The final working position of the grinding unit is set with the stop (7-27/1).

Turn the stop (7-27/1) using the star handle (7-27/2) until the desired working position is reached.



Figure 7-28 Closing the locking handle

Then lock the grinding unit with the locking handle (7-28/1) on the left side of the machine.

ATTENTION

The grinding unit must be engaged in the interlock!

7.3.4 Moving the grinding unit to the grinding position



Figure 7-29 "Grinding unit" feed lever

Lower the grinding unit to just above the cross knife using the feed lever (7-29/1).

To do this, unlock the feed lever by pressing the button (7-29/2) on the hand wheel and pull it down.

Once the desired position has been reached, release button (7-29/2).

7. Operation

ATTENTION

The grinding wheel may only touch the workpiece when the drives are switched on.

When grinding cross knives, ensure that the grinding wheel does not touch the collar of the knife.

7.3.5 Surface grinding the cross knife



Figure 7-30 Control panel

Close the safety flap (3-2/1).

Start the rotary table, grinding wheel, coolant pump and suction unit by pressing the "Drives On/Off" button (7-30/1).

ATTENTION

Always grind with coolant, otherwise there is a risk of overheating the workpieces and a fire hazard in the suction unit!

NOTE

The machine is electrically secured and the units can only be operated when the safety flap is closed.

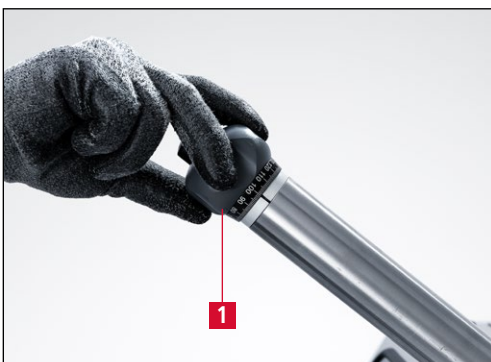

Figure 7-31 "Grinding unit" fine adjustment

For grinding, feed the grinding unit with the fine adjustment (7-31/1) using the hand wheel of the feed lever until a clear spark is visible.

7. Operation



Figure 7-32 Grinding cross knives

Allow the machine to work without further infeed until the sparking subsides.

Feed repeatedly until the workpiece is evenly surface-ground.



Figure 7-33 Moving the grinding unit upwards

After the grinding process, move the grinding unit upwards with the feed lever (7-33/1) until the drives stop automatically.

To do this, unlock the feed lever by pressing the button (7-33/2) on the hand wheel and push it upwards.

Open the safety flap (3-2/1).



Figure 7-34 Rinsing the cross knife

Remove and rinse the cross knife (7-34). Only rinse the mincer plate from above.

Turn the cross knife over and grind the back as described below.

Clamp the cross knife (Chapter 7.3.2)

Set the working position (Chapter 7.3.3)

Move the grinding unit into the grinding position (Chapter 7.3.4)

Surface grind the cross knife (Chapter 7.3.5)

Remove the cross knife and mincer plate from the rotary table.

Rinse the cross knife, mincer plate and rotary table (7-34).

7. Operation

Then oil with a lubricant approved for use in the food industry to prevent corrosion (see Chapter 8.1.1).

NOTE

The rotary table must be cleaned after each grinding process (see Chapter 8.1.2).

In order to prevent corrosion, oil the cutting tool after grinding with a lubricant approved for use in the food industry (see Chapter 8.1.1).

7. Operation

7.4 Setting the coolant supply



Figure 7-35 Switching on/off the coolant supply

The coolant pump is switched on and off by pressing the “Coolant On/Off” button (7-35/1) when the control unit is activated.



Figure 7-36 Coolant tap

The coolant supply is regulated using the coolant tap (7-36/1).

Turning the coolant tap clockwise = less coolant

Turning the coolant tap counterclockwise = more coolant



Figure 7-37 Coolant hose

The coolant hose (7-37/1) is flexible and must be adjusted so that the coolant flows directly onto the grinding point between the workpiece and grinding wheel.

ATTENTION

Check the coolant level regularly before grinding.

Always grind with coolant, otherwise there is a risk of overheating the workpieces and a fire hazard in the suction unit!

7. Operation

7.5 Dressing the CBN grinding wheel

7.5.1 Positioning the dressing device on the rotary table

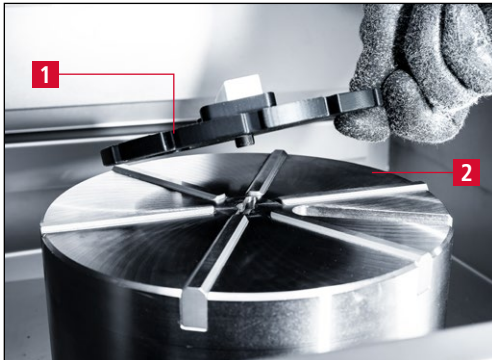

Figure 7-38 Positioning the dressing device on the rotary table

If grinding performance decreases during the grinding process, the grinding wheel must be dressed.

Place the dressing device (7-38/1) on the rotary table (7-38/2).

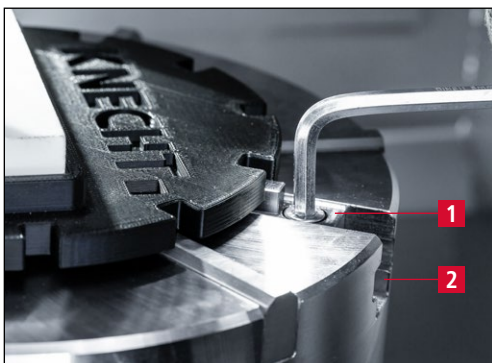

Figure 7-39 Fixing the dressing device

Move the driver (7-39/1) in the guide groove (7-39/2) and fix the dressing device against rotation using a hexagon screwdriver AF5 mm.

ATTENTION

The rotary table may not rotate during dressing!

7. Operation

7.5.2 Setting the working position



Figure 7-40 Grinding unit in working position

Move the grinding unit to the working position.

The correct working position is reached when the dressing stone is caught by the grinding wheel (see Figure 7-40).



Figure 7-41 Opening the locking handle

The position of the grinding unit is adjusted as follows:

Pull out the locking handle (7-41/1) on the left side of the machine and open the interlock of the grinding unit by turning it to a horizontal position.



Figure 7-42 Moving the grinding unit to the working position

Pull the grinding unit forwards over the dressing stone to the working position using the handle (7-42/1).

7. Operation



Figure 7-43 Closing the locking handle

Then lock the grinding unit with the locking handle (7-43/1) on the left-hand side of the machine.

ATTENTION

The grinding unit must be engaged in the interlock!

7.5.3 Moving the grinding unit into position



Figure 7-44 "Grinding unit" feed lever

Move the grinding wheel down to a few millimeters above the dressing stone.

To do this, unlock the feed lever (7-44/1) by pressing the button (7-44/2) on the hand wheel and pull it down.

Once the desired position has been reached, release the button (7-44/2) on the hand wheel.

7. Operation

7.5.4 Dressing the grinding wheel



Figure 7-45 Control panel

Close the safety flap (3-2/1).

Start the grinding wheel by pressing the "Grinding wheel On/Off" button (7-45/1).



Figure 7-46 "Grinding unit" fine adjustment

Feed the grinding wheel with the fine adjustment on the hand wheel (7-46/1) of the feed lever.

As soon as the grinding wheel touches the dressing stone, feed a little.

The grinding wheel is ready for use again.

7. Operation

7.6 Changing the grinding wheel



For all work on the grinding machine, observe the locally applicable safety and accident prevention regulations as well as instructions in the "Safety" and "Important notes" section of the operating instructions.



Figure 7-47 Locking the grinding wheel

The grinding wheel is easily changed using the locking pin (7-47/1) and a hexagon screwdriver AF6 mm.

To release the grinding wheel, insert the locking pin (7-47/1) into the hole above the grinding wheel. To do this, turn the grinding wheel until the locking pin blocks the rotation.

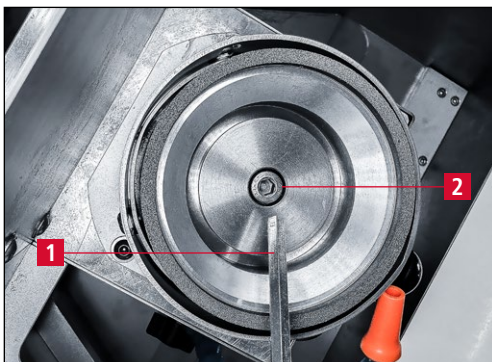

Figure 7-48 Loosening the grinding wheel

Then loosen the fastening screw (7-48/2) **clockwise** from below using a hexagon screwdriver AF6 mm (7-48/1).

Remove the used grinding wheel.



Figure 7-49 Changing the grinding wheel

Attach the new grinding wheel (7-49/1) and tighten **counterclockwise** using a hexagon screwdriver AF6 mm.

Pull out the locking pin (7-47/1) again.

After changing the grinding wheel, the grinding wheel guard (7-49/2) must be readjusted. The grinding wheel must not protrude more than 1.5 cm below the guard.

7. Operation

NOTE

Ensure that the locking pin (7-47/1) is removed when switching on the machine (turn the wheel briefly by hand).

ATTENTION

Only original abrasives from KNECHT Maschinenbau GmbH are permitted to be used.

KNECHT Maschinenbau GmbH assumes no responsibility for the use of non-original abrasives.

8. Care and maintenance



For all work on the grinding machine, observe the locally applicable safety and accident prevention regulations as well as instructions in the "Safety" and "Important notes" section of the operating instructions.

8.1 Cleaning

The machine must be cleaned after each grinding operation, otherwise the grinding abrasion dries and is difficult to remove.

Clean the windows with soft cleaning cloths and window cleaning agent.

After cleaning, we recommend the products listed below for care of the machine (see also the table of cleaning agents and lubricants in Chapter 8.1.1).

ATTENTION

Never spray directly into the opening of the water tray when cleaning.

8.1.1 Cleaning agent and lubricant table

Cleaning / Lubrication work	Interflon	WÜRTH	SHELL	EXXON Mobil	OEST	Ballistol
Cleaning and care of machine parts	Dry Clean Stainless Steel	Stainless steel care spray	Risella 917	Marcol 82	New Process Multispray	
Lubrication of threads and sliding surfaces	Fin Grease	Multi-purpose grease	Gadus S2 V1002	Mobilith SHC 100	IXELON GOC 190	
Lubrication nipple rotary table			Gadus S2 V1002	Mobilith SHC 100	IXELON GOC 190	
Lubrication nipples lubrication block			Gadus S5 V142 W0018		IXELON LT000 EP	
Lubricate cutting tools						H1 Spray

ATTENTION

To prevent corrosion, non-corrosion-resistant cutting tools must be oiled after grinding.

Only use lubricants approved for use in the food industry.

8. Care and maintenance

ATTENTION

We recommend Ballistol H1 Spray.

It has NSF H1 approval in accordance with the FDA (Food and Drug Administration) and is permitted for use in the entire food industry.

8.1.2 Cleaning the rotary table



Figure 8-1 Rinsing the rotary table

The rotary table must be rinsed with water before and after each grinding process.

8.1.3 Checking the suction unit

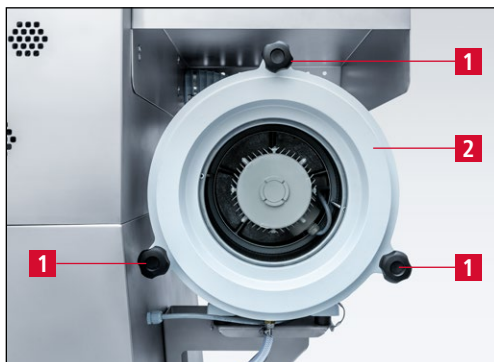

Figure 8-2 Opening the suction unit

Check the suction unit weekly and replace the filter mat or metal filter if necessary.

To do this, open the three star handles (8-2/1) of the suction unit and remove the cover (8-2/2).

8. Care and maintenance



Figure 8-3 Removing the filter

Pull the filter (8-3/1) out towards the front.



Figure 8-4 Removing the filter mat

Remove the filter mat (8-4/1) from the metal filter (8-4/2) and check both.

If the filter mat (8-4/1) is oily or heavily soiled, it must be exchanged.

The metal filter (8-4/2) must be exchanged if there are visible signs of corrosion.

8.1.4 Cleaning the suction hose

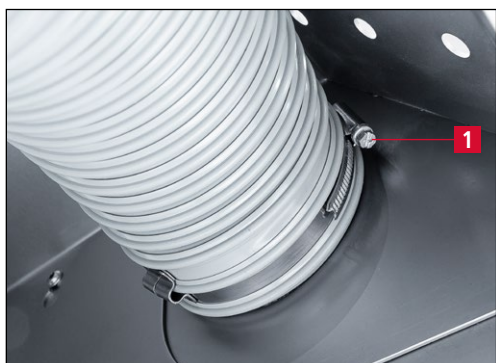

Figure 8-5 Cleaning the suction hose

Once a year, the suction hose D 100 mm (8-5/1) must be detached from the suction unit and rinsed with warm water.

8. Care and maintenance

8.2 Maintenance plan (one-shift operation)

Interval	Assembly	Maintenance task
Daily	All machine surfaces	Clean with soft cleaning cloth and care spray.
	Grinding room	Clean metal sheets with a washing brush.
	Safety flap	Clean the safety flap windows.
	Coolant unit	Check the filling quantity. If water has been added, be sure to measure the concentration of the coolant lubricant (see Chapter 8.4.2) and top up if necessary.
		Empty and clean the strainer basket.
Weekly	Suction Unit	Check the filter (see Chapter 8.1.4).
Monthly	Rotary table	Check for any unevenness and, if necessary grind flat.
		Lubricate the rotary table bearing at the side lubrication nipple
	Recirculating ball bearing guides	Lubricate the lubrication nipples on the lubrication block for the recirculating ball bearing guides (see Chapter 8.3).
Annually		Contact the service department of KNECHT Maschinenbau GmbH

8. Care and maintenance

8.3 Lubrication

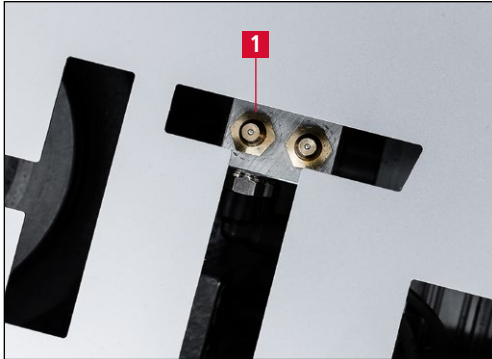

Figure 8-6 Lubrication nipples on the lubrication block for the recirculating ball bearing guides

All bearing points are equipped with waterproof, grease-lubricated roller bearings and therefore maintenance-free.

The recirculating ball bearing guides on the grinding unit must be lubricated with fluid grease every four weeks. This is done through the KNECHT lettering in the cover of the machine.

Attach the grease press to the two lubrication nipples (8-6/1) and lubricate the recirculating ball bearing guides on the grinding unit.

We recommend "OEST IXELON LT 000 EP" or a corresponding commercial fluid grease.

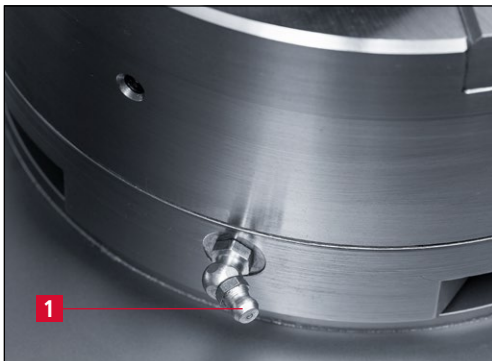

Figure 8-7 Rotary table lubrication nipple

The lubrication nipple on the rotary table (8-7/1) must be lubricated with multi-purpose grease "OEST IXELON GOC 190" every four weeks.

8. Care and maintenance

8.4 Coolant additive

It is absolutely essential to add a corrosion-inhibiting coolant additive to the coolant water. To do this, add approx. 35 liters of water with approx. 1.8 liters of Colometa SBF-PN coolant additive to the coolant unit (mixing ratio 1:20).

ATTENTION

No other coolant additive may be used without the permission of KNECHT Maschinenbau GmbH.

8.4.1 Measuring the cooling lubricant concentration

ATTENTION

Measurement errors are eliminated by carrying out a zero line adjustment with the provided calibration fluid before using the refractometer.

To do this, turn the small upper screw of the measuring device until zero is displayed.



Figure 8-8 Measuring the cooling lubricant concentration

The concentration of the cooling lubricant is measured using the hand refractometer supplied.

To do this, use the pipette (8-8/1) and place a few drops of the coolant water on the test area (8-8/2) of the refractometer.



Figure 8-9 Reading the refractive index

Then read off the refractive index of the liquid (Figure 8-9).

The value read in °Brix multiplied by 1.6 gives the concentration in %.

8. Care and maintenance

8.4.2 Maintenance schedule for cooling lubricant

- Check filling volume daily.
- If water has been topped up, be sure to measure the concentration (see Chapter 8.4.1) and top up with cooling lubricant if necessary.
- Check the cooling lubricant concentration weekly.

Coolant additive Colometa SBF-PN	Refractometer °Brix 3–5				
	Date	°BRIX	Conc %	Notes etc.	Signature

The value read in °Brix multiplied by 1.6 gives the concentration in %.

The concentration must always be between 3–5 °Brix (corresponds to 5% to 9% concentration).

Check the cooling lubricant regularly for smell and appearance. The cooling lubricant must be exchanged every three months at the latest (biological hazard due to germ formation in the cooling lubricant).

9. Disassembly and disposal

9.1 Disassembly

All operating materials must be disposed of properly.

Secure moving parts against slippage.

Disassembly must be conducted by a qualified specialist.

9.2 Disposal

After the machine has reached the end of its service life, it must be disposed of by a qualified specialist. In exceptional situations, and after consultation with KNECHT Maschinenbau GmbH, the machine may be returned.

Operating materials (e.g. grinding wheels, coolant etc.) must be disposed of correctly.

10. Service, spare parts and accessories

10.1 Postal address

KNECHT Maschinenbau GmbH
Witschwender Straße 26
88368 Bergatreute
Germany

Phone +49-7527-928-0
Fax +49-7527-928-32

mail@knecht.eu
www.knecht.eu

10.2 Service

Service line:

For address, see postal address

service@knecht.eu

10.3 Wear and spare parts

If you need spare parts, please use the spare parts list provided with the machine. Please place your order using the format described below.

When ordering, please always provide: (example)

Type of machine	(W200II)
Machine number	(560570200)
Designation of assembly	(Motor trolley left)
Designation of individual part	(STAR-Linear carriage)
Item number	(14)
Drawing number (article number)	(405L-08-0213)
Quantity	(1 pc)

We are always happy to answer any questions.

10. Service, spare parts and accessories

10.4 Accessories

10.4.1 Abrasives used etc.

Designation	Dimensions	Article number	Note
CBN-grinding wheel	d.100xd.40x40	412F-73-0106	installed on delivery
Filter mat (suction unit)	d200*x340	418P-55-0300	installed on delivery
Coolant additive Colometa SBF-PN		417C-25-0011	included in scope of delivery
Fluid grease IXELON LT000 EP	900 g	417B-02-0100	included in scope of delivery
Hand refractometer with calibration fluid		413L-20-0100	included in scope of delivery

ATTENTION

Only original abrasives, wear and spare parts from KNECHT Maschinenbau GmbH are permitted to be used.

KNECHT Maschinenbau GmbH assumes no responsibility for the use of non-original parts.

If you require abrasives or other accessories, please contact our sales staff and distributors, or KNECHT Maschinenbau GmbH directly.

Thank you for choosing KNECHT!

11. Appendix

11.1 EU Declaration of Conformity

in accordance with EU Directive 2006/42/EU

- Machinery 2006/42/EU
- Electromagnetic Compatibility 2014/30/EU

We hereby declare that the machine designated as follows, due to its construction and design, as well as the version we placed on the market, complies with the relevant fundamental safety and health requirements of the applicable EU Directive.

In case of a modification of the machine not agreed with us, this declaration loses its validity.

Designation of the machine:	Surface Grinding Machine
Model designation:	W200II
Machine number:	from no. 560570200
Applicable harmonized standards, in particular	DIN EN 12100-1 DIN EN ISO 13857 DIN EN 12100-2 DIN EN 60204-1 DIN EN 349
Responsible for documentation:	Peter Heine (B. Eng. Mechanical Engineering BA) Phone +49-7527-928-15 p.heine@knecht.eu
Manufacturer:	KNECHT Maschinenbau GmbH Witschwender Straße 26 88368 Bergatreute Germany

A complete technical documentation is available. The operating instructions document for the machine is available in its original version and in the native language of the user.

The validity of the declaration expires in the event of changes to the legal requirements.

Bergatreute, May 31, 2024

KNECHT Maschinenbau GmbH

Markus Knecht
CEO

